

FOR CAR USE ONLY/NUR FÜR AUTOMOBIL GEBRAUCH/POUR APPLICATION AUTOMOBILE UNIQUEMENT/PARA USO EN AUTOMÓVILES/SOLO PER L'UTILIZZO IN AUTOMOBILE/ENDAST FÖR BILBRUK/ALLEEN VOOR GEBRUIK IN DE AUTO/ ТОЛЬКО ДЛЯ ИСПОЛЬЗОВАНИЯ В АВТОМОБИЛЯХ/DO UŻYCIA TYLKO W SAMOCHODZIE

ALPINE®

CD RECEIVER WITH ADVANCED BLUETOOTH
CDE-178BT
DIGITAL MEDIA RECEIVER WITH ADVANCED BLUETOOTH
iDE-178BT
CD/USB RECEIVER
CDE-175R



Bluetooth®



(CDE-178BT/iDE-178BT only)

- OWNER'S MANUAL
Please read before using this equipment.
- BEDIENUNGSANLEITUNG
Lesen Sie diese Bedienungsanleitung bitte vor Gebrauch des Gerätes.
- MODE D'EMPLOI
Veuillez lire avant d'utiliser cet appareil.
- MANUAL DE OPERACIÓN
Léalo antes de utilizar este equipo.
- ISTRUZIONI PER L'USO
Si prega di leggere prima di utilizzare il attrezzatura.
- ANVÄNDARHANDLEDNING
Innan du använder utrustningen bör du läsa igenom denna användarhandledning.
- GEBRUIKERSHANDLEIDING
Lees deze aanwijzingen aandachtig alvorens dit toestel te gebruiken.
- РУКОВОДСТВО ПО ЭКСПЛУАТАЦИИ
Прочтите настоящее руководство перед началом использования оборудования.
- INSTRUKCJA OBSŁUGI
Prosimy zapoznać się z tą instrukcją przed przystąpieniem do użytkowania urządzenia.

ALPINE ELECTRONICS MARKETING, INC.

1-7, Yukigaya-Otsukamachi, Ota-ku,
Tokyo 145-0067, JAPAN
Phone: 03-5499-4531

ALPINE ELECTRONICS OF AMERICA, INC.

19145 Gramercy Place, Torrance,
California 90501, U.S.A.
Phone 1-800-ALPINE-1 (1-800-257-4631)

ALPINE ELECTRONICS OF CANADA, INC.

777 Supertest Road, Toronto,
Ontario M3J 2M9, Canada
Phone 1-800-ALPINE-1 (1-800-257-4631)

ALPINE ELECTRONICS OF AUSTRALIA PTY. LTD.

161-165 Princes Highway, Hallam
Victoria 3803, Australia
Phone 03-8787-1200

ALPINE ELECTRONICS GmbH

Wilhelm-Wagenfeld-Str. 1-3, 80807 München, Germany
Phone 089-32 42 640

ALPINE ELECTRONICS OF U.K. LTD.

Alpine House
Fletchamstead Highway, Coventry CV4 9TW, U.K.
Phone 0870-33 33 763

ALPINE ELECTRONICS FRANCE S.A.R.L.

(RCS PONTOISE B 338 101 280)
98, Rue de la Belle Etoile, Z.I. Paris Nord II,
B.P. 50016, 95945 Roissy Charles de Gaulle
Cedex, France
Phone 01-48638989

ALPINE ITALIA S.p.A.

Viale C. Colombo 8, 20090 Trezzano
Sul Naviglio (MI), Italy
Phone 02-484781

ALPINE ELECTRONICS DE ESPAÑA, S.A.

Portal de Gamarra 36, Pabellón, 32
01013 Vitoria (Alava)-APDO 133, Spain
Phone 945-283588

EN

DE

FR

ES

IT

SE

NL

RU

PL

Operating Instructions

WARNING

WARNING	6
CAUTION	6
PRECAUTIONS	6

Getting Started

Accessory List	9
Turning Power On and Off	9
Source Selection	9
Detaching and Attaching the Front Panel	9
Detaching	9
Attaching	9
Initial System Start-Up	10
Adjusting Volume	10
Lowering Volume Quickly	10
Setting the Time and Calendar	10

Radio

Listening to Radio	11
Presetting Stations Manually	11
Presetting Stations Automatically	11
Tuning to Preset Stations	11
Frequency Search Function	11

RDS

Turning AF (Alternative Frequencies) ON/OFF	12
Priority News	12
Setting PTY31 (Emergency Broadcast) reception	12
Receiving RDS Regional (Local) Stations	13
PI SEEK Setting	13
Receiving Traffic Information	13
PTY (Programme Type) Tuning	13
Receiving Traffic Information While Playing CD or Radio	14
Displaying Radio Text	14

CD/MP3/WMA/AAC

(CDE-178BT/CDE-175R only)

Playback	14
Repeat Play	15
M.I.X. (Random Play)	15
Searching for CD Text	15

Folder/File Name Search (Concerning MP3/WMA/AAC)	15
Folder Name Search mode	15
File Name Search mode	15
Search Position Memory	15
About MP3/WMA/AAC	16
Terminology	17

Sound Setting

Adjusting Subwoofer Level/Bass Level/ Treble Level/Balance (Between Left and Right)/ Fader (Between Front and Rear)/Defeat	17
Audio Setup	18
Equalizer Presets (Factory's EQ)	18
Adjusting the Parametric Equalizer Curve (Parametric EQ)	18
Adjusting the Band	18
Adjusting the Frequency (Freq.)	18
Setting the Bandwidth (Q)	18
Adjusting the Level	18
Setting the Source Volume Level	18
Turning Subwoofer ON/OFF	19
Setting the Subwoofer Phase	19
Setting the Subwoofer System	19
External Device	19
Connecting to an External Amplifier	19
Setting the Media Xpander mode (MX Setup)	19
Customizing the Media Xpander setting	19
Setting the Time Correction Unit (TCR Parameter)	20
Adjusting the Time Correction (T.Correction)	20
Adjusting the SPATIAL	20
Adjusting the Crossover Settings (X-Over)	20
Adjusting the Channel (Ch.)	20
Selecting the Cut-Off Frequency (Freq.)	20
Adjusting the Slope	20
Adjusting the Level (Lev.)	20
Storing the Parametric EQ/T.Correction/ X-Over Settings	20
Recalling the Stored Parametric EQ/ T.Correction/X-Over Settings	21
About Time Correction	21
Example 1: Front Left Seat	21
Example 2: All Seats	21
About the Crossover	22

Other Functions

Displaying the Text	23
About the indication display	24
About "Text"	24
Setting your favourite source to the FAV button (FAV Setup) (CDE-175R only)	25
Set your favourite source	25
Recall your favourite source	25
Option Menu Setting	25
Applying Tunelt	26
Adjusting the sound via Smartphone	26
Facebook Notification Function	26
Receiving Notification (Ready on future update)	26
Displaying Notification List (Ready on future update)	26

SETUP

Setting	27
General Setting	27
Setting the Clock Display (Clock Mode)	27
Setting the Time to automatically be adjusted	27
Setting of Calendar Display Pattern Switching (Calendar)	27
Setting your favourite source to the FAV button (FAV Setup) (CDE-175R only)	28
Setting the Menu Language	28
Setting the AUX SETUP mode	28
Setting the AUX NAME mode	28
Playing MP3/WMA/AAC Data (Play Mode) (CDE-178BT/CDE-175R only)	28
Sound (Beep) Guide Function	28
Demonstration	28
Setting Adaptive Steering Remote Control	29
Display Setting	29
Changing Lighting Colour	29
Dimmer Control	29
Dimmer Level Setting	29
Scroll Type Setting	29
Scroll Setting (Text Scroll)	29
Opening Message ON/OFF Setting	30
Tuner Setting	30
Setting the TUNER (FM) tone quality	30
iPod&USB Setting	30
Setting the USB Skip function	30
iPod/iPhone Search Mode Setting	30
Application Setting (APP)	30
Setting the communication mode with a Smartphone (Alpine APP)	30
Setting the TTS (Text To Speech) volume	30

BT Hands Free Calling

(CDE-178BT/iDE-178BT only)

Setup Before Using	31
About BLUETOOTH	31
Before Using BLUETOOTH Function	31
How to connect to a BLUETOOTH compatible device (Pairing)	31
Pairing a BLUETOOTH compatible device with SSP (Secure Simple Pairing)	31
Pairing a BLUETOOTH compatible device without SSP (Secure Simple Pairing)	31
BLUETOOTH SETUP	32
Setting the BLUETOOTH Connection (Bluetooth IN)	32
Setting the BLUETOOTH Device	32
Setting the Visible Mode	32
Pairing a BLUETOOTH Device from the unit	32
Setting the BLUETOOTH sound quality	33
Adjusting the volume (VOL LV ADJ)	33
Sound Type setting (Type Setup)	33
Setting the caller information display/text message indicator ON/OFF	33
Setting the Phone Book Update	33
Setting the Phone Book Auto Update ON/OFF (Auto)	33
Setting the Phone Book Manual Update ON/OFF (Manual)	33
Changing the Phone book List Order	33
Setting the Received Calls automatically (Auto Answer)	34
Displaying the phone service provider name	34
Selecting the output speaker	34
Displaying the firmware version	34
Updating the firmware	34
Hands-Free Phone Control	34
About the Hands-Free Phone	34
Answering a Call	34
Hanging up the Telephone	34
Voice Control Operation	34
Calling	35
Redialing a Number in Outgoing History	35
Dialing a Number in Incoming History	35
Dialing a Number in Incoming Missed Call History	35
Dialing a Number in the Phone Book	35
Phone book Alphabet Search Function	35

- Call waiting function..... 36
- Preset a number in the Phone Menu
(Shortcut dial)..... 36
- Dialing the preset number 36
- Adjusting the volume when receiving a
Call..... 36
- Muting the microphone input quickly
(Voice Mute)..... 36
- Call Switching Operation 36
- Bluetooth Audio Operation..... 36
- Recalling the Bluetooth Audio Mode 37
- Selecting the desired Song 37
- Selecting the desired Group (Folder)..... 37
- Pausing 37
- Searching for a desired song 37

USB Memory (optional)

- Connecting the USB Memory (optional) 37
- Playback 37
- Repeat Play..... 38
- M.I.X. (Random Play) 38
- Searching for a desired Song..... 38
- Select Folder 38
- Search Position Memory 38

iPod/iPhone (optional)

- Connecting an iPod/iPhone 39
- Setting the iPod Control..... 39
- Playback 39
- Searching for a desired Song..... 40
- Direct Search Function..... 40
- Change Playlist/Artist/Album/Genre/
Composer/Episode..... 41
- Alphabet search function 41
- Search Position Memory 41
- Random Play Shuffle (M.I.X.) 41
- Repeat Play..... 41

vTuner internet radio (iPhone) (Optional)

- Listening to vTuner..... 42
- Storing the desired station to Favourite
List 42
- Jumping to Favourite station..... 42
- Deleting stored station from Favourite List.... 42
- Searching for a Desired Station 42

Information

- In Case of Difficulty43
- Basic.....43
- Radio43
- CD.....43
- MP3/WMA/AAC.....44
- Audio.....44
- iPod.....44
- Indication for CD Player.....44
- Indication for USB Memory.....44
- Indication for iPod Mode45
- Indication for vTuner Mode45
- BLUETOOTH mode45
- Specifications46

Installation and Connections

- WARNING** 47
- CAUTION**..... 47
- PRECAUTIONS**..... 47
- Installation48
- Removal48
- iPod/iPhone Connection
 (sold separately).....49
- Remove the iPod/iPhone.....49
- USB Memory Connection
 (sold separately).....49
- Connect USB Memory49
- Remove USB Memory49
- Mounting the Microphone
 (Only for CDE-178BT/IDE-178BT)49
- Using the Rear AUX Input Connector.....49
- Connections50

Operating Instructions

WARNING

WARNING

This symbol means important instructions. Failure to heed them can result in serious injury or death.

DO NOT OPERATE ANY FUNCTION THAT TAKES YOUR ATTENTION AWAY FROM SAFELY DRIVING YOUR VEHICLE.

Any function that requires your prolonged attention should only be performed after coming to a complete stop. Always stop the vehicle in a safe location before performing these functions. Failure to do so may result in an accident.

KEEP THE VOLUME AT A LEVEL WHERE YOU CAN STILL HEAR OUTSIDE NOISES WHILE DRIVING.

Excessive volume levels that obscure sounds such as emergency vehicle sirens or road warning signals (train crossings, etc.) can be dangerous and may result in an accident. LISTENING AT LOUD VOLUME LEVELS IN A CAR MAY ALSO CAUSE HEARING DAMAGE.

DO NOT DISASSEMBLE OR ALTER.

Doing so may result in an accident, fire or electric shock.

USE ONLY IN CARS WITH A 12 VOLT NEGATIVE GROUND.

(Check with your dealer if you are not sure.) Failure to do so may result in fire, etc.

KEEP SMALL OBJECTS SUCH AS BATTERIES OUT OF THE REACH OF CHILDREN.

Swallowing them may result in serious injury. If swallowed, consult a physician immediately.

USE THE CORRECT AMPERE RATING WHEN REPLACING FUSES.

Failure to do so may result in fire or electric shock.

DO NOT BLOCK VENTS OR RADIATOR PANELS.

Doing so may cause heat to build up inside and may result in fire.

USE THIS PRODUCT FOR MOBILE 12V APPLICATIONS.

Use for other than its designed application may result in fire, electric shock or other injury.

DO NOT PLACE HANDS, FINGERS OR FOREIGN OBJECTS IN INSERTION SLOTS OR GAPS.

Doing so may result in personal injury or damage to the product.

CAUTION

This symbol means important instructions. Failure to heed them can result in injury or material property damage.

HALT USE IMMEDIATELY IF A PROBLEM APPEARS.

Failure to do so may cause personal injury or damage to the product. Return it to your authorized Alpine dealer or the nearest Alpine Service Centre for repairing.

PRECAUTIONS

Product Cleaning

Use a soft dry cloth for periodic cleaning of the product. For more severe stains, please dampen the cloth with water only. Anything else has the chance of dissolving the paint or damaging the plastic.

Temperature

Be sure the temperature inside the vehicle is between +60°C (+140°F) and -10°C (+14°F) before turning your unit on.

Moisture Condensation

You may notice the CD playback sound wavering due to condensation. If this happens, remove the disc from the player and wait about an hour for the moisture to evaporate.

Damaged Disc

Do not attempt to play cracked, warped, or damaged discs. Playing a bad disc could severely damage the playback mechanism.

Maintenance

If you have problems, do not attempt to repair the unit yourself. Return it to your Alpine dealer or the nearest Alpine Service Station for servicing.

Never Attempt the Following

Do not grip or pull out the disc while it is being pulled back into the player by the automatic reloading mechanism.

Do not attempt to insert a disc into the unit when the unit power is off.

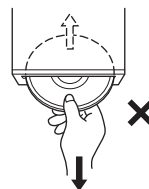

Inserting Discs

Your player accepts only one disc at a time for playback. Do not attempt to load more than one disc.

Make sure the label side is facing up when you insert the disc. "Error" will be displayed on your player if you insert a disc incorrectly. If "Error" continues to be displayed even though the disc has been inserted correctly, push the RESET switch with a pointed object such as a ballpoint pen.

Playing a disc while driving on a very bumpy road may result in skips, but this will not scratch the disc or damage the player.

New Discs

To prevent the CD from jamming, "Error" is displayed if discs with irregular surfaces are inserted or if discs are inserted incorrectly. When a new disc is ejected immediately after initial loading, use your finger to feel around the inside of the centre hole and outside edge of the disc. If you feel any small bumps or irregularities, this could inhibit proper loading of the disc. To remove the bumps, rub the inside edge of the hole and outside edge of the disc with a ballpoint pen or other such instrument, then insert the disc again.

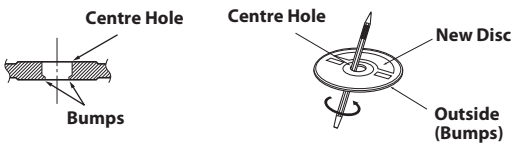

Irregular Shaped Discs

Be sure to use round discs only for this unit and never use any special shaped discs.

Use of anything but round discs may cause damage to the mechanism.



Installation Location

Make sure this unit will not be installed in a location subjected to:

- Direct sun and heat
- High humidity and water
- Excessive dust
- Excessive vibrations

Correct Handling

Do not drop the disc while handling. Hold the disc so you will not leave fingerprints on the surface. Do not affix tape, paper, or gummed labels to the disc. Do not write on the disc.

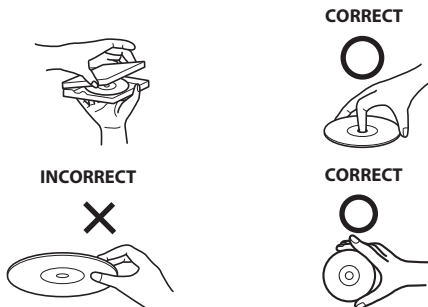

Disc Cleaning

Fingerprints, dust, or soil on the surface of the disc could cause the CD player to skip. For routine cleaning, wipe the playing surface with a clean, soft cloth from the centre of the disc to the outer edge. If the surface is heavily soiled, dampen a clean, soft cloth in a solution of mild neutral detergent before cleaning the disc.



Disc Accessories

There are various accessories available on the market for protecting the disc surface and improving sound quality. However, most of them will influence the thickness and/or diameter of the disc. Using such accessories can cause the disc to be out of standard specifications and may create operational problems. We recommend not using these accessories on discs played in Alpine CD players.

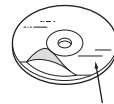

Transparent Sheet

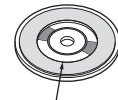

Disc Stabilizer

On handling Compact Discs (CD/CD-R/CD-RW)

- Do not touch the surface.
- Do not expose the disc to direct sunlight.
- Do not affix stickers or labels.
- Clean the disc when it is dusty.
- Make sure that there are no bumps around the disc.
- Do not use commercially available disc accessories.

Do not leave the disc in the car or the unit for a long time. Never expose the disc to direct sunlight. Heat and humidity may damage the CD and you may not be able to play it again.

To customers using CD-R/CD-RW

- If a CD-R/CD-RW cannot be played back, make sure the last recording session was closed (finalized).
- Finalize the CD-R/CD-RW if necessary, and attempt playback again.

About media that can be played

Use only compact discs with the label side showing the CD logo marks below.



If you use unspecified compact discs, correct performance cannot be guaranteed.

You can play CD-Rs (CD-Recordables)/CD-RWs (CD-ReWritables) which have been recorded only on audio devices. You can also play CD-Rs/CD-RWs containing MP3/WMA/AAC formatted audio files.

- Some of the following CDs may not play on this unit: Flawed CDs, CDs with fingerprints, CDs exposed to extreme temperatures or sunlight (e.g., left in the car or this unit), CDs recorded under unstable conditions, CDs on which a recording failed or a re-recording was attempted, copy-protected CDs which do not conform to the audio CD industry standard.

- Use discs with MP3/WMA/AAC files written in a format compatible with this unit. For details, refer to “About MP3/WMA/AAC” on page 16.
- ROM data other than audio files contained in a disc will not produce sound when played back.

Protecting the USB connector

- Only a USB Memory or iPod/iPhone can be connected to the USB port on this unit. Correct performance using other USB products cannot be guaranteed.
- If the USB connector is used, be sure to use a USB extension cable (supplied). A USB hub is not supported.
- Depending on the connected USB Memory device, the unit may not function or some functions may not be performed.
- The audio file format that can be played back on the unit is MP3/WMA/AAC.
- Artist/song name, etc., can be displayed. Certain, special characters may not be correctly displayed.

On Handling USB Memory

CAUTION

Alpine accepts no responsibility for lost data, etc., even if data, etc. is lost while using this product.

- To prevent malfunction or damage, note the following points.
Read the USB Memory Owner’s Manual thoroughly.
Do not touch the terminals by hand or metal.
Do not subject USB Memory to excessive shock.
Do not bend, drop, disassemble, modify or soak in water.
- Avoid usage or storage in the following locations:
Anywhere in the car exposed to direct sunlight or high temperatures.
Anywhere the possibility of high humidity or corrosive substances are present.
- Fix the USB Memory in a location where driver operation will not be hindered.
- USB Memory may not function correctly at high or low temperature.
- Use only certified USB Memory. Pay attention that even certified USB Memory, may not function correctly depending on its type or state.
- USB Memory function is not guaranteed. Use USB Memory according to the terms of agreement.
- Depending on the settings of the USB Memory type, memory state or encoding software, the unit may not play back or display properly.
- A file that is copy-protected (copyright protection) cannot be played back.
- USB Memory may take time to start playback. If there is a particular file other than audio in the USB Memory, it may take considerable time before the file is played back or searched.
- The unit can play back “mp3”, “wma” or “m4a” file extensions.
- Do not add the above extensions to a file other than audio data. This non-audio data will not be recognized. The resulting playback may contain noise that can damage speakers and/or amplifiers.
- It is recommended to back up important data on a personal computer.
- Do not remove the USB device while playback is in progress. Change SOURCE to something other than USB, then remove the USB device to prevent possible damage to its memory.

- *Windows Media and the Windows logo are trademarks, or registered trademarks of Microsoft Corporation in the United States and/or other countries.*
- *iPhone, iPod, iPod classic, iPod nano, and iPod touch are trademarks of Apple Inc., registered in the U.S. and other countries.*
- *“Made for iPod,” and “Made for iPhone,” mean that an electronic accessory has been designed to connect specifically to iPod, or iPhone, respectively, and has been certified by the developer to meet Apple performance standards. Apple is not responsible for the operation of this device or its compliance with safety and regulatory standards. Please note that the use of this accessory with iPod, or iPhone may affect wireless performance.*
- *The BLUETOOTH® word mark and logos are registered trademarks owned by the Bluetooth SIG, Inc. and any use of such marks by Alpine Electronics, Inc. is under license. Other trademarks and trade names are those of their respective owners.*
- *MPEG Layer-3 audio coding technology licensed from Fraunhofer IIS and Thomson. Supply of this product only conveys a license for private, non-commercial use and does not convey a license nor imply any right to use this product in any commercial (i.e. revenue-generation) real time broadcasting (terrestrial, satellite, cable and/or any other media), broadcasting/streaming via internet, intranets and/or other networks or in other electronic content distribution systems, such as pay-audio or audio-on-demand applications. An independent license for such use is required. For details, please visit <http://www.mp3licensing.com>*
- *© 2012 Nokia. All rights reserved. Nokia and Works with Nokia are trademarks or registered trademarks of Nokia Corporation.*
- *vTuner™ is a trademark of Nothing Else Matters Software, Ltd., Other featured words or symbols, used to identify the source of merchandise or services, may be the trademarks of their respective owners.*
- *Android is a trademark of Google Inc.*

Getting Started

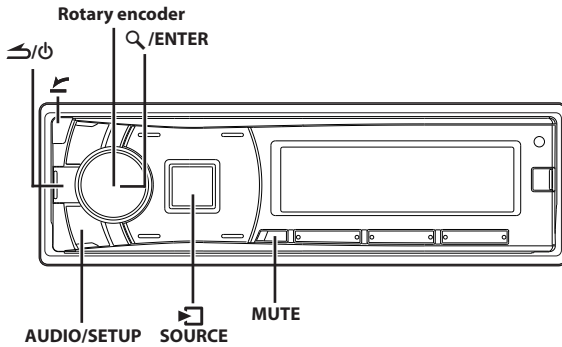

Accessory List

- Head unit1
- Power cable.....1
- USB extension cable.....1
- Microphone*1
- Mounting sleeve.....1
- Carrying case1
- Rubber Cap1
- Hex Bolt1
- Screw (M5 × 8)4
- Owner's Manual.....1 set

* Only for CDE-178BT/iDE-178BT.

Turning Power On and Off

Press to turn on the unit.

Notes

- The unit can be turned on by pressing any other button except .
- /SOURCE key blinks each time the unit is powered on.

Press and hold for at least 2 seconds to turn off the unit.

Note

- The first time power is turned on, the volume will start from level 12.

Source Selection

Press /SOURCE to change the source.

Tuner → Disc*1 → USB/iPod*2 → BLUETOOTH Audio*3 → vTuner*4 → Auxiliary*5 → Tuner

*1 Only for CDE-178BT/CDE-175R.

*2 Displayed only when the iPod/iPhone is connected.

*3 Displayed only when Bluetooth IN is set to ON, refer to "Setting the BLUETOOTH Connection (Bluetooth IN)" on page 32.

*4 Displayed only when Alpine APP is set to USB, refer to "Setting the communication mode with a Smartphone (Alpine APP)" on page 30.

*5 Displayed only when the AUX IN is set to ON, refer to "Setting the AUX SETUP mode" on page 28.

Detaching and Attaching the Front Panel

Detaching

- 1 Turn off the unit power.
- 2 Press (OPEN) to open the front panel (figure 1).
To close the front panel, press the left side until it locks as shown in the figure 2.

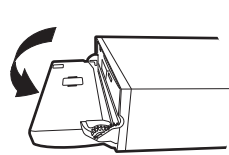

figure 1

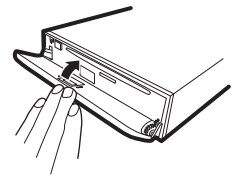
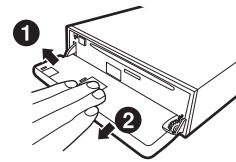

figure 2

- 3 Grasp the front panel firmly, slide to the left , and then pull to remove.



Notes

- The front panel may become hot in normal usage (especially the connector terminals on the back of the front panel). This is not a malfunction.
- To protect the front panel, place it in the supplied carrying case.
- When detaching the front panel, do not apply excessive force as it may result in malfunction.
- Do not leave the front panel open, or drive the car with the panel open as it may result in an accident or malfunction.

Attaching

- 1 Insert the right side of the front panel into the main unit. Align the groove on the front panel with the projections on the main unit.
- 2 Push the left side of the front panel until it locks firmly into the main unit.

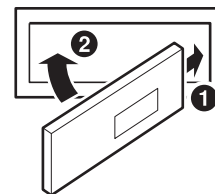

Notes

- Before attaching the front panel, make sure that there is no dirt or dust on the connector terminals and no foreign object between the front panel and the main unit.
- Attach the front panel carefully, holding the sides of the front panel to avoid pushing buttons by mistake.

Initial System Start-Up

Be sure to press the RESET switch when using the unit for the first time, after changing the car battery, etc.

- 1 Turn off the unit power.
- 2 Press **OPEN** to open the front panel, and then remove it.
- 3 Press **RESET** with a ballpoint pen or similar pointed object.

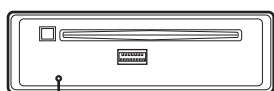

RESET switch

Adjusting Volume

Turn the **Rotary encoder** until the desired sound is obtained.

Lowering Volume Quickly

Activating the Audio Mute function will instantly lower the volume level by 20 dB.

- 1 Press **MUTE** to activate the **MUTE** mode.
The audio level will decrease by about 20 dB.
- 2 Pressing **MUTE** again will bring the audio back to its previous level.

Setting the Time and Calendar

- 1 Press and hold **AUDIO/SETUP** for at least 2 seconds to activate the **SETUP** selection mode.
- 2 Turn the **Rotary encoder** to select the **General** mode, and then press **ENTER**.
Audio ↔ General ↔ Display ↔ Tuner ↔ iPod&USB ↔ Application ↔ Bluetooth* ↔ Audio
* CDE-178BT/iDE-178BT only.
- 3 Turn the **Rotary encoder** to select **Clock Adjust**, and then press **ENTER**.
- 4 Turn the **Rotary encoder** to set year.
- 5 Press **ENTER**.
- 6 Repeat steps 4 and 5 above to set month, date, hour and minute.
- 7 Press and hold **AUDIO/SETUP** for at least 2 seconds to return to normal mode.

Notes

- Pressing **BACK** returns to the previous **SETUP** mode.
- If no operation is performed for 60 seconds, **SETUP** is cancelled.
- To synchronise the clock to another clock/watch or radio time announcement, press and hold **ENTER** for at least 2 seconds after setting the "hour". Minutes will reset to 00. If the display shows over "30" minutes when you do this, the time will advance one hour.
- Even when **Auto Clock** is set to **ON** (refer to "Setting the Time to automatically be adjusted" on page 27), the time can be adjusted manually. At the same time, if there is an adjustment request from **RDS**, the time will be adjusted automatically by **RDS** data.

Controllable with Remote Control

This unit can be controlled with an optional Alpine remote control. For details, consult your Alpine dealer. Point the optional remote control transmitter at the remote-control sensor.

Remote control sensor

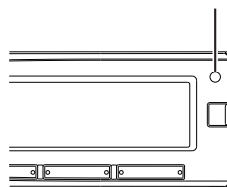

Connectable to Remote Control Interface Box

With an optional Alpine Steering Wheel Remote Control Interface Box (not included), this unit is controllable from the vehicles steering wheel controls. For details, contact your Alpine dealer.

Radio

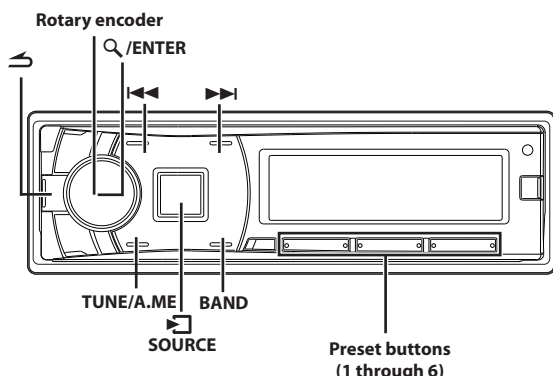

Listening to Radio

- 1 Press **Q/ENTER** / **SOURCE** to select Tuner mode.
- 2 Press **BAND** repeatedly until the desired radio band is displayed.
FM1 → FM2 → FM3 → MW → LW → FM1
- 3 Press **TUNE/A.ME** to select the tuning mode.
DX (Distance mode) → LOCAL (Local mode) → MANUAL (Manual mode) → DX (Distance mode)
Note
 - The initial mode is Distance mode.**Distance mode:**
Both strong and weak stations will be automatically tuned in (Automatic Seek Tuning).
Local mode:
Only strong stations will be automatically tuned in (Automatic Seek Tuning).
Manual mode:
The frequency is manually tuned in steps (Manual tuning).
- 4 Press **◀◀** or **▶▶** to tune in the desired station.
In Manual mode, holding down **◀◀** or **▶▶** will change the frequency continuously.

Presetting Stations Manually

Tune in the station you want to store. Press and hold, for at least 2 seconds, any one of the **preset buttons (1 through 6)** into which you wish to store the station.

The display shows the band, preset number and station frequency memorized.

Notes

- A total of 30 stations can be stored in the preset memory (6 stations for each band; FM1, FM2, FM3, MW and LW).
- If you store a station in a preset memory which already has a station, the current station will be cleared and replaced with the new station.

Presetting Stations Automatically

- 1 Press **BAND** repeatedly until the desired radio band is displayed.
- 2 Press and hold **TUNE/A.ME** for at least 2 seconds.
The frequency on the display continues to change while the automatic memory is in progress. The tuner will automatically seek and store 6 strong stations in the selected band. They will be stored into preset buttons 1 to 6 in order of signal strength. When the automatic memory has been completed, the tuner goes to the station stored in preset location No.1.

Note

- If no stations are stored, the tuner will return to the original station you were listening to before the auto memory procedure began.

Tuning to Preset Stations

Select the desired band, then press any one of the **station preset buttons (1 through 6)** that has your desired radio station in memory.

The display shows the band, preset number and frequency of the station selected.

Frequency Search Function

You can search for a radio station by its frequency.

- 1 Press **Q/ENTER** in Radio mode to activate Frequency search mode.
- 2 Turn the **Rotary encoder** to select the desired frequency.
- 3 Press **Q/ENTER** to receive the selected frequency.

Note

- Press **↵** in the search mode to cancel. Or, the search mode will be cancelled if no operation is performed for 60 seconds.

RDS

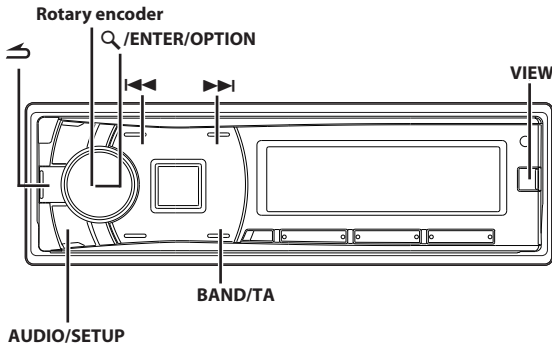

Turning AF (Alternative Frequencies) ON/OFF

The RDS (Radio Data System) is a radio information system using the 57 kHz subcarrier of regular FM broadcast. The RDS allows you to receive a variety of information such as traffic information, station names, and to automatically re-tune to a stronger transmitter that is broadcasting the same programme.

- 1 Press and hold **AUDIO/SETUP** for at least 2 seconds to activate the **SETUP** mode.
- 2 Turn the **Rotary encoder** to select the **Tuner** mode, and then press **Q /ENTER**.
- 3 Turn the **Rotary encoder** to select the **AF**, and then press **Q /ENTER**.
AF ↔ News ↔ Alert PTY31 ↔ RDS Regional ↔ PI Seek ↔ FM Tuner Setup ↔ AF
- 4 Turn the **Rotary encoder** to select **ON** or **OFF**.
- 5 Press and hold **AUDIO/SETUP** for at least 2 seconds to return to normal mode.

Notes

- When the **AF ON** mode is selected, the unit automatically tunes to a strong signal station in the **AF** list.
- Use the **AF OFF** mode when automatic re-tuning is not required.
- When the **PTY31 (Emergency Broadcast)** reception is set to **ON** (refer to "Setting **PTY31 (Emergency Broadcast)** reception" on page 12), if the unit receives the **PTY31 (Emergency Broadcast)** signal, the unit will show "Alarm!" in the display automatically.
- Press **↵** to return to the previous mode.
- If no operation is performed for 60 seconds in the **SETUP** mode, the setting mode is cancelled.

The RDS digital data includes the following:

PI	Programme Identification
PS	Programme Service Name
AF	List of Alternative Frequencies
TP	Traffic Programme
TA	Traffic Announcement
EON	Enhanced Other Networks
PTY	Programme Type

Priority News

This function allows you to preset to give priority to the News programme. You will never miss the News programme as the unit automatically gives priority to the News programme whenever it begins broadcasting, and interrupts the programme you are currently listening. This feature is functional when your unit is set to a mode other than the **LW** and **MW** modes.

- 1 Press and hold **AUDIO/SETUP** for at least 2 seconds to activate the **SETUP** mode.
- 2 Turn the **Rotary encoder** to select the **Tuner** mode, and then press **Q /ENTER**.
- 3 Turn the **Rotary encoder** to select the **News**, then press **Q /ENTER**.
- 4 Turn the **Rotary encoder** to select **ON** or **OFF**.
- 5 Press and hold **AUDIO/SETUP** for at least 2 seconds to return to normal mode.

Notes

- Pressing **↵** during the procedure will return to the previous mode.
- If no operation is performed for 60 seconds in the **SETUP** mode, the setting mode is cancelled.
- In the **Priority News** function, unlike in the **TA** function, the volume does not increase automatically.

Setting PTY31 (Emergency Broadcast) reception

Turn **PTY31 (Emergency Broadcast)** reception **ON/OFF**.

- 1 Press and hold **AUDIO/SETUP** for at least 2 seconds to activate the **SETUP** mode.
- 2 Turn the **Rotary encoder** to select the **Tuner** mode, and then press **Q /ENTER**.
- 3 Turn the **Rotary encoder** to select **Alert PTY31**, and then press **Q /ENTER**.
- 4 Turn the **Rotary encoder** to select **ON** or **OFF**.
If you set to **ON**, emergency broadcasts are received regardless of source. "Alarm!" is displayed during reception.
- 5 Press and hold **AUDIO/SETUP** for at least 2 seconds to return to normal mode.
When an emergency broadcast is received, the volume level will be automatically changed to the memorized level in the traffic information mode. For details, refer to "Receiving Traffic Information" on page 13.

Notes

- Pressing **↵** during the procedure will return to the previous mode.
- If no operation is performed for 60 seconds in the **SETUP** mode, the setting mode is cancelled.

Receiving RDS Regional (Local) Stations

- 1 Press and hold **AUDIO/SETUP** for at least 2 seconds to activate the **SETUP** mode.
- 2 Turn the **Rotary encoder** to select the **Tuner mode**, and then press **Q / ENTER**.
- 3 Turn the **Rotary encoder** to select **RDS Regional**, and then press **Q / ENTER**.
- 4 Turn the **Rotary encoder** to select **ON** or **OFF**.
In the **OFF** mode, the unit automatically keeps receiving the related local RDS station.

- 5 Press and hold **AUDIO/SETUP** for at least 2 seconds to return to normal mode.

Notes

- Pressing **↵** during the procedure will return to the previous mode.
- If no operation is performed for 60 seconds in the **SETUP** mode, the setting mode is cancelled.

PI SEEK Setting

- 1 Press and hold **AUDIO/SETUP** for at least 2 seconds to activate the **SETUP** mode.
- 2 Turn the **Rotary encoder** to select the **Tuner mode**, and then press **Q / ENTER**.
- 3 Turn the **Rotary encoder** to select **PI Seek**, and then press **Q / ENTER**.
- 4 Turn the **Rotary encoder** to select **ON** or **OFF**.
- 5 Press and hold **AUDIO/SETUP** for at least 2 seconds to return to normal mode.

Notes

- Pressing **↵** during the procedure will return to the previous mode.
- If no operation is performed for 60 seconds in the **SETUP** mode, the setting mode is cancelled.

Receiving Traffic Information

- 1 Press and hold **BAND / TA** for at least 2 seconds so that the "TA" indicator lights up.
- 2 Press **◀** or **▶** to select your desired traffic information station.
When a traffic information station is tuned in, the "TP" indicator lights up.
Traffic information is heard only when it is being broadcast. If traffic information is not being broadcast, the unit is set in the standby mode. When a traffic information broadcast begins, the unit automatically receives it and the display shows "T.INFO". When the traffic information broadcast is over, the unit will automatically set in the standby mode.

Notes

- If the traffic information broadcast signal falls below a certain level, the unit remains in the receiving mode for 1 minute. If the signal remains below a certain level for over 1 minute, the "TA" indicator blinks.
- If you do not want to listen to the traffic information being received, lightly press **◀** or **▶** to skip that traffic information message. The TA mode will remain in the ON position to receive the next traffic information message.
- If the volume level is changed while receiving traffic information, the changed volume level will be memorized. When traffic information is received next time, the volume level will be automatically adjusted to the level memorized.
- In the TA mode, the SEEK tuning selects only the TP stations.

PTY (Programme Type) Tuning

- 1 Press and hold **Q / ENTER / OPTION** for at least 2 seconds to activate the **Option** menu while the unit is in **Radio (FM receiving)** mode.
- 2 Turn the **Rotary encoder** to select the **PTY Select**, then press **Q / ENTER**.
The Programme Type of the station being currently received will be displayed for 5 seconds.
If there is no receivable PTY broadcast, "No PTY" will be displayed for 5 seconds.
If no RDS station can be received, the display shows "No PTY".
- 3 Turn the **Rotary encoder** to choose the desired programme type while the PTY (programme type) is being displayed.
- 4 Press **Q / ENTER** after selecting the programme type to start searching for a station in the selected programme type.
The chosen programme type display blinks during searching and lights when a station is found.
If no PTY station is found, "No PTY" will be displayed for 5 seconds.
- 5 Press and hold **Q / ENTER / OPTION** for at least 2 seconds to return to normal mode.

Receiving Traffic Information While Playing CD or Radio

- 1 Press and hold **BAND/TA** for at least 2 seconds so that the "TA" indicator lights up.
- 2 Press **I◀◀** or **▶▶I** to select a traffic information station if necessary.

When a traffic information broadcast starts, the unit automatically mutes the CD player or the regular FM broadcast. When the traffic information broadcast finishes, the unit automatically returns to the original source play before the traffic information broadcast began.

When traffic information stations cannot be received:

In the tuner mode:

When the TP signal can no longer be received for over 1 minute, the "TA" indicator blinks.

In the CD mode:

When the TP signal can no longer be received, the traffic information station of another frequency will be selected automatically.

Note

- The receiver is equipped with the EON (Enhanced Other Networks) function in order to keep track of additional alternate frequencies to the AF list. The "EON" indicator lights up while an RDS EON station is being received. If the station being received does not broadcast the traffic information, the receiver automatically tunes in the related station that broadcasts the traffic information when it occurs.

- 3 Press and hold **BAND/TA** for at least 2 seconds to deactivate the Traffic Information mode.

The "TA" indicator goes out.

Displaying Radio Text

Text messages from a radio station can be displayed.

Press **VIEW** while receiving FM in the radio mode to select the Radio Text display.

The display will change every time the button is pressed. For details, refer to "Displaying the Text" on page 23.

CD/MP3/WMA/AAC (CDE-178BT/CDE-175R only)

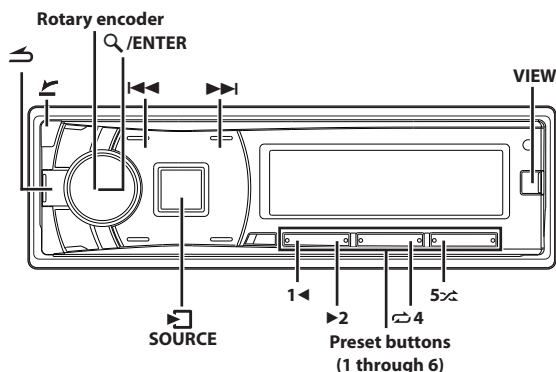

Playback

- 1 Press **▲** (**OPEN**).
The front panel will open.
- 2 Insert a disc with the label side facing up.
The disc will be pulled into the unit automatically.

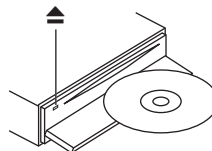

Notes

- Close the front panel manually.
- When a disc is already inserted, press **□** / **SOURCE** to switch to the Disc mode.

- 3 While playing back MP3/WMA/AAC, press **1 ◀** or **▶ 2** to select the desired folder.
Pressing and holding **1 ◀** or **▶ 2** will change folders continuously.
- 4 Press **I◀◀** or **▶▶I** to select the desired track (file).
Pressing and holding **I◀◀** or **▶▶I** will fast backward/fast forward track continuously.
- 5 To pause playback, press **▶/II**.
Pressing **▶/II** again will resume playback.
- 6 After pressing **▲** (**OPEN**) to open the front panel, press **▲** to eject the disc.

Notes

- Do not remove a CD during its eject cycle. Do not load more than one disc at a time. A malfunction may result from doing either.
- Three-inch (8 cm) CDs cannot be used.

- Any file protected by DRM (Digital Rights Management) copy protection, cannot be played back on this unit.
- The track display for MP3/WMA/AAC data playback is the file numbers recorded on the disc.
- The playback time may not be correctly displayed when a VBR (Variable Bit Rate) recorded file is played back.
- Press **VIEW** to switch the display. For details, refer to “Displaying the Text” on page 23.

Repeat Play

1 Press **↺** 4.

The song is played back repeatedly.

RPT*1 → RPT □*2 → (off) → RPT

*1 Only a track/file is repeatedly played back.

*2 Only files in a folder are repeatedly played back (MP3/WMA/AAC mode only).

2 To cancel repeat play, select (off) with the above procedure.

M.I.X. (Random Play)

1 Press 5 **↻**.

The songs are played back in random sequence.

MIX □*1 → MIX ALL*2 → (off) → MIX □

*1 Only files in a folder are played back in random sequence (MP3/WMA/AAC mode only).

*2 The tracks/files are played back in random sequence.

2 To cancel M.I.X. play, select (off) with the above procedure.

Searching for CD Text

On discs utilizing CD Text, songs can be searched and played by using their recorded titles. For discs without CD Text, searches are made using the track numbers associated with each song.

1 Press **Q** /ENTER during play.

This will set the search mode.

2 Turn the Rotary encoder to select the desired track, and then press **Q** /ENTER.

This will play the selected track.

Notes

- Press **↵** in the search mode to cancel. Or, the search mode is cancelled if no operation is performed for 60 seconds.
- When CD Text Search is made during M.I.X. play, the M.I.X. play mode will be cancelled.
- If any one of the **preset buttons (1 through 6)** is pressed in the search mode, a search can be made quickly by skipping to the specified location. For details, refer to “Direct Search Function” on page 40.

Folder/File Name Search (Concerning MP3/WMA/AAC)

Folder and file names may be searched and displayed during playback.

Folder Name Search mode

- 1 During MP3/WMA/AAC playback, press **Q** /ENTER to activate the search mode.
- 2 Turn the Rotary encoder to select Folder Name Search mode, and then press **Q** /ENTER.
- 3 Turn the Rotary encoder to select the desired folder.
- 4 Press and hold **Q** /ENTER for at least 2 seconds to play back the first file in the selected folder.

Notes

- If no operation is performed for 60 seconds, the search mode is cancelled.
- To search for files in the Folder Name Search mode, press **Q** /ENTER. Files in the folder may be searched.
- Press **↵** to exit Folder Name Search mode in step 3 in order to select File Name Search mode.
- When Folder Name Search is made during M.I.X. play, the M.I.X. play mode will be cancelled.
- The root folder of a disc is displayed as “\ROOT”.
- If any one of the **preset buttons (1 through 6)** is pressed in the search mode, a search can be made quickly by skipping to the specified location. For details, refer to “Direct Search Function” on page 40.

File Name Search mode

- 1 During MP3/WMA/AAC playback, press **Q** /ENTER to activate the search mode.
- 2 Turn the Rotary encoder to select File Name Search mode, and then press **Q** /ENTER.
- 3 Select the desired file by turning the Rotary encoder.
- 4 Press **Q** /ENTER to play back the selected file.

Notes

- If no operation is performed for 60 seconds, the search mode is cancelled.
- Press **↵** in the search mode to return to the previous mode.
- When File Name Search is made during M.I.X. play, the M.I.X. play mode will be cancelled.
- If any one of the **preset buttons (1 through 6)** is pressed in the search mode, a search can be made quickly by skipping to the specified location. For details, refer to “Direct Search Function” on page 40.

Search Position Memory

During playback, you can quickly return to the last-selected hierarchy level in the search mode.

Press **↵**.

The hierarchy you selected last in the search mode is displayed.

About MP3/WMA/AAC

⚠ CAUTION

Except for private use, duplicating audio data (including MP3/WMA/AAC data) or distributing, transferring, or copying it, whether for free or for a fee, without permission of the copyright holder is strictly prohibited by the Copyright Act and by international treaty.

What is MP3?

MP3, whose official name is “MPEG Audio Layer 3,” is a compression standard prescribed by the ISO, the International Standardization Organization and MPEG which is a joint activity institution of the IEC. MP3 files contain compressed audio data. MP3 encoding is capable of compressing audio data at extremely high ratios, reducing the size of music files to as much as one-tenth their original size. This is achieved while still maintaining near CD quality. The MP3 format realises such high compression ratios by eliminating the sounds that are either inaudible to the human ear or masked by other sounds.

What is WMA?

WMA, or “Windows Media™ Audio,” is compressed audio data. WMA is similar to MP3 audio data.

What is AAC?

AAC is the abbreviation for “Advanced Audio Coding”, and is a basic format of audio compression used by MPEG2 or MPEG4.

Method for creating MP3/WMA/AAC files

Audio data is compressed using software with MP3/WMA/AAC codecs. For details on creating MP3/WMA/AAC files, refer to the user’s manual for that software.

MP3/WMA/AAC files that are playable on this device have the file extensions “mp3”/“wma”/“m4a”. Files with no extension cannot be played back (WMA ver. 7, 8 and 9 are supported). Protected files are not supported, neither are raw AAC files (using the “.aac” extension). There are many different versions of the AAC format. Confirm that the software being used conforms to the acceptable formats listed above. It’s possible that the format may be unplayable even though the extension is valid.

Playback of AAC files encoded by iTunes is supported.

Supported playback sampling rates and bit rates

MP3

Sampling rates: 48 kHz, 44.1 kHz, 32 kHz, 24 kHz, 22.05 kHz, 16 kHz, 12 kHz, 11.025 kHz, 8 kHz
Bit rates: 8 - 320 kbps

WMA

Sampling rates: 48 kHz, 44.1 kHz, 32 kHz
Bit rates: 32 - 192 kbps

AAC

Sampling rates: 48 kHz, 44.1 kHz, 32 kHz, 24 kHz, 22.05 kHz, 16 kHz, 12 kHz, 11.025 kHz, 8 kHz
Bit rates: 16 - 320 kbps

This device may not play back correctly depending on sampling rates. In the USB mode, the playback time may not be correctly displayed when a VBR (Variable Bit Rate) recorded file is played back.

ID3 tags/WMA tags

This device supports ID3 tag v1 and v2, and WMA/AAC tag. If tag data is in an MP3/WMA/AAC file, this device can display the title (track title), artist name, and album name ID3 tag/WMA/AAC tag data. This device can only display single-byte alphanumeric characters (up to 32 for ID3 tags and up to 32 for WMA tags) and the underscore. For non-supported characters, “No Support” is displayed or the character is displayed as space.

If information contains characters other than ID3 tag information, the audio file may not be played back.

The tag information may not be correctly displayed, depending on the contents.

Playing back MP3/WMA/AAC

MP3/WMA/AAC files are prepared, then written to a CD-R, CD-RW using CD-R writing software or stored to a USB Memory. A disc can hold up to 509 files/folders (including Root Folders), and the maximum number of folders is 255.

Playback may not be performed if a disc exceeds the limitations described above.

Do not make a file’s playback time more than 1 hour.

Media supported

The media that this device can play back are CD-ROMs, CD-Rs, and CD-RWs.

This device also can play back USB Memory media.

Corresponding File Systems

This device supports discs formatted with ISO9660 Level 1 or Level 2. Under the ISO9660 standard, there are some restrictions to remember. The maximum nested folder depth is 8 (including the root directory). The number of characters for a folder/file name is limited.

Valid characters for folder/file names are letters A-Z (all caps), numbers 0-9, and ‘_’ (underscore).

This device also can play back discs in Joliet, Romeo, etc., and other standards that conform to ISO9660. However, sometimes the file names, folder names, etc., are not displayed correctly.

This device also supports FAT 12/16/32 for USB Memory device.

Formats supported

This device supports CD-ROM XA, Mixed Mode CD, Enhanced CD (CD-Extra) and Multi-Session.

This device cannot correctly play back discs recorded with Track At Once or packet writing.

Order of files

Files are played back in the order that the writing software writes them to the disc. Therefore, the playback order may not be what is expected. Verify the writing order in the software’s documentation. The playback order of the folders and files is as follows.

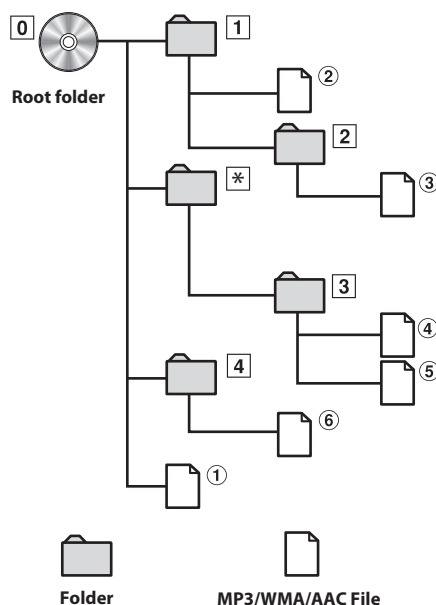

* The folder No./ folder Name will not be displayed if no file is contained in the folder.

Terminology

Bit rate

This is the "sound" compression rate specified for encoding. The higher the bit rate, the higher the sound quality, but also the larger the files.

Sampling rate

This value shows how many times per second the data is sampled (recorded). For example, music CDs use a sampling rate of 44.1 kHz, so the sound is sampled (recorded) 44,100 times per second. The higher the sampling rate, the higher the sound quality, but also the larger the volume of data.

Encoding

Converting music CDs, WAVE (AIFF) files, and other sound files into the specified audio compression format.

Tag

Song information such as track titles, artist names, album names, etc., written into MP3/WMA/AAC files.

Root folder

The root folder (or root directory) is found at the top of the file system. The root folder contains all folders and files. It is created automatically for all burned discs.

Sound Setting

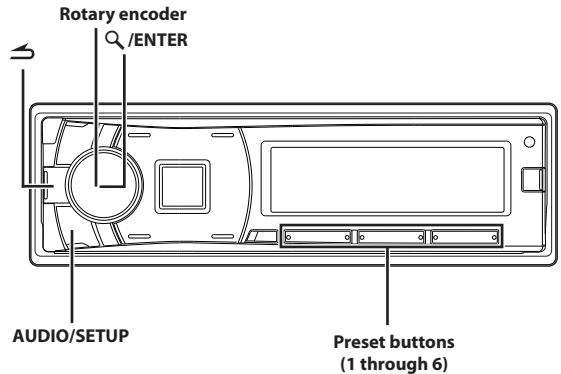

Adjusting Subwoofer Level/Bass Level/Treble Level/Balance (Between Left and Right)/Fader (Between Front and Rear)/Defeat

1 Press **AUDIO** repeatedly to choose the desired mode.

Each press changes the mode as follows:

SubW LEVEL*¹ → BASS*² → TREBLE*² → BALANCE → FADER → DEFEAT → VOLUME → SubW LEVEL

*¹ When the Subwoofer mode is set to OFF, its level cannot be adjusted, refer to "Turning Subwoofer ON/OFF" on page 19.

*² Adjustable only when DEFEAT is OFF.

Subwoofer Level	0 ~ 15
Bass Level	-7 ~ 7
Treble Level	-7 ~ 7
Balance	-15(L) ~ 15(R)
Fader	-15(R) ~ 15(F)
Defeat	ON/OFF
Volume	0 ~ 35

Note

- If no operation is performed for 5 seconds after selecting the SubW LEVEL, BASS, TREBLE, BALANCE, FADER or DEFEAT mode, the unit automatically returns to normal mode.

2 Turn the **Rotary encoder** until the desired sound is obtained in each mode.

By setting DEFEAT ON, previously adjusted level settings of BASS and TREBLE will return to the factory defaults.

Audio Setup

You can flexibly customize the unit to suit your own preference and usage. From the AUDIO SETUP menu, Audio Setting can be modified.

Use steps 1 to 5 to select one of the setting modes to modify. See the applicable section below for details about the selected setting item.

- 1 Press and hold **AUDIO/SETUP** for at least 2 seconds to activate the **SETUP** mode.
- 2 Turn the **Rotary encoder** to select **Audio**, and then press **Q/ENTER**.
Audio*¹ ↔ General ↔ Display ↔ Tuner ↔ iPod&USB ↔ Application ↔ Bluetooth*² ↔ Audio
**1 Adjustment cannot be performed during a call.
2 Only for CDE-178BT/iDE-178BT.
- 3 Turn the **Rotary encoder** to select the desired **sound setting menu**, and then press **Q/ENTER**.
Factory's EQ*^{3/4} ↔ Parametric EQ*^{3/5} ↔ VOL LV ADJ ↔ Subwoofer ↔ Subwoofer Phase*⁶ ↔ Subwoofer System*⁶ ↔ Power IC ↔ MX Setup*³ ↔ TCR Parameter*³ ↔ T.Correction*³ ↔ Spatial*³ ↔ X-Over*³ ↔ Factory's EQ
**3 Adjustment cannot be performed when DEFEAT is set to ON.
*4 Any changes made to either Factory's EQ or Parametric EQ are reflected in the others' settings.
*5 In step 3, nine sound adjustment items can be selected in Parametric EQ mode. Turn the **Rotary encoder** to select the desired item, and then press **Q/ENTER** to continue to step 4.
6 These functions are inoperable when Subwoofer is set to OFF.
- 4 Turn the **Rotary encoder** to change the setting, and then press **Q/ENTER**.
- 5 Press and hold **AUDIO/SETUP** for at least 2 seconds to return to normal mode.

Notes

- Pressing **↩** returns to the previous Sound menu mode.
- If no operation is performed for 60 seconds, Sound menu mode is cancelled.

Equalizer Presets (Factory's EQ)

10 typical equalizer settings are preset at the factory for a variety of musical source material. User settings are created in the Parametric EQ mode.

User ↔ Flat (Initial setting) ↔ Pops ↔ Rock ↔ News ↔ Jazz&Blues ↔ Electrical Dance ↔ Hip Hop&Rap ↔ Easy Listening ↔ Country ↔ Classical

Note

- The Parametric EQ is used to create the Factory's EQ settings.

Adjusting the Parametric Equalizer Curve (Parametric EQ)

You can modify the Equalizer settings to create a response curve more appealing to your personal taste.

- 1 After selecting **Parametric EQ** from the **Audio Setup** mode, turn the **Rotary encoder** to select the desired band, then press **Q/ENTER**.

- 2 Turn the **Rotary encoder** to select the desired frequency within the selected band, then press **Q/ENTER**.
- 3 Repeat step 2 to adjust the **Bandwidth and Level** within the selected band.

Adjusting the Band

Setting contents:

Band1/Band2/Band3/Band4/Band5/Band6/Band7/Band8/
Band9

Adjusting the Frequency (Freq.)

Adjustable frequency bands: 20 Hz to 20 kHz

Band1: 20 Hz ~ 100 Hz (63 Hz)
Band2: 63 Hz ~ 315 Hz (125 Hz)
Band3: 125 Hz ~ 500Hz (250 Hz)
Band4: 250 Hz ~ 1 kHz (500 Hz)
Band5: 500 Hz ~ 2 kHz (1 kHz)
Band6: 1 kHz ~ 4 kHz (2 kHz)
Band7: 2 kHz ~ 7.2 kHz (4 kHz)
Band8: 5.8 kHz ~ 12 kHz (8 kHz)
Band9: 9 kHz ~ 20 kHz (16 kHz)

Setting the Bandwidth (Q)

Setting contents:

3.0 (Initial setting) / 4.0 / 5.0

Notes

- Settings exceeding the frequency of adjacent bands are not available.
- While adjusting the Parametric EQ, you should consider the frequency response of the connected speakers.
- When the Parametric EQ is adjusted, the adjustment for Factory's EQ becomes ineffective.
- The Parametric EQ setting can be configured when Defeat is OFF.

Adjusting the Level

Setting contents:

-7 to +7 (Initial setting: 0)

Notes

- Band2 and Band8 are the same as the Bass and Treble controls. Their Level adjustment can also be controlled by pressing **AUDIO** and selecting Bass Level or Treble Level. Refer to "Adjusting Subwoofer Level/Bass Level/Treble Level/Balance (Between Left and Right)/Fader (Between Front and Rear)/Defeat" on page 17.
- Settings exceeding the frequency of adjacent bands are not available.
- While adjusting the Parametric EQ, you should consider the frequency response of the connected speakers.
- The Parametric EQ is used to create the Factory's EQ settings.

Setting the Source Volume Level

The output level of each source is individually adjustable. For example, if the Tuner level sounds lower than Disc, its output can be adjusted without affecting the other sources.

■ **Setting item:** VOL LV ADJ

■ **Further setting items:** Tuner / Disc*¹ / USB / iPod / BT Audio*² / vTuner / AUX

Setting contents:

-14 dB ~ +14 dB

*1 Only for CDE-178BT/CDE-175R.

*2 Only for CDE-178BT/iDE-178BT.

Turning Subwoofer ON/OFF

When the subwoofer is on, you can adjust the subwoofer output level (refer to “Adjusting Subwoofer Level/Bass Level/Treble Level/Balance (Between Left and Right)/Fader (Between Front and Rear)/Defeat” on page 17).

Setting item: Subwoofer

Setting contents:

OFF / ON (Initial setting)

OFF:

No subwoofer signal is output from the Subwoofer RCA Connectors (refer to “Connections” on page 50).

ON:

The subwoofer signal is output from the Subwoofer RCA Connectors (refer to “Connections” on page 50).

Setting the Subwoofer Phase

The subwoofer output phase is toggled Subwoofer Normal (0°) or Subwoofer Reverse (180°). To adjust the level, turn the **Rotary encoder**.

Setting item: Subwoofer Phase

Setting contents:

0° (Initial setting) / 180°

Setting the Subwoofer System

When the subwoofer is on, you can select either System 1 or System 2 for the desired subwoofer effect.

Setting item: Subwoofer System

Setting contents:

System 1/ System 2 (Initial setting)

System 1:

Subwoofer level changes according to the main volume setting.

System 2:

Subwoofer level change is different from the main volume setting. For example, even at low volume settings, the subwoofer is still audible.

External Device

Connecting to an External Amplifier

When an external amplifier is connected, sound quality can be improved by stopping the power supply of the built-in amplifier.

Setting item: Power IC

Setting contents:

OFF / ON (Initial setting)

OFF:

Use this mode when the line output of this unit is used to drive an external amplifier. In this setting, the head unit's internal amplifier is turned OFF and can not drive speakers.

ON:

The speakers are driven by the built-in amplifier.

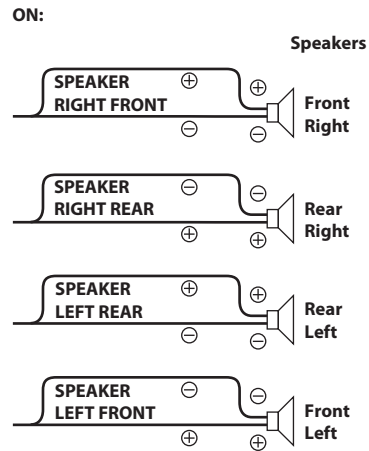
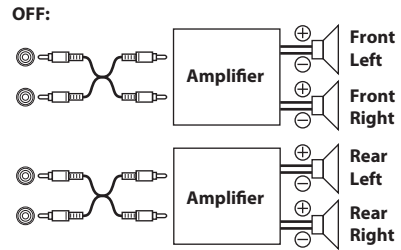

Note

- No sound is produced by the system when the Power IC is set to OFF.

Setting the Media Xpander mode (MX Setup)

MX (Media Xpander) makes vocals or instruments sound distinct regardless of the music source. The CD and iPod, etc. will be able to reproduce the music clearly even in cars with a lot of road noise.

Setting item: MX Setup

1 Turn the **Rotary encoder** to select the source to which you want to apply Media Xpander, and then press **Q/ENTER**.

CD*1 ↔ CMPM*1/*2 ↔ USB ↔ iPod ↔ BT Audio*3 ↔ vTuner ↔ AUX

*1 Only for CDE-178BT/CDE-175R.

*2 Be applied for MP3/WMA/AAC files in disc.

*3 Only for CDE-178BT/iDE-178BT.

2 Turn the **Rotary encoder** to select the Media Xpander level, and then press **Q/ENTER**.

OFF ↔ Level 1 ↔ Level 2 ↔ Level 3 ↔ Customize

Customizing the Media Xpander setting

If Customize is selected in step 2, you can modify the Media Xpander to suit your personal preference.

3 Turn the **Rotary encoder** to select the Band, and then press **Q/ENTER**. Band1 (Low frequencies) → Band3 (High frequencies)

Band1 (Bass) ↔ Band2 (Mid) ↔ Band3 (High)

- 4** Turn the **Rotary encoder** to adjust the level, and then press **Q/ENTER**.
LEVEL: 0 ~ 8
- 5** Repeat steps 3 to 4 to complete the setting of other bands.

Note

- There is no MX mode for FM, MW and LW radio.

Setting the Time Correction Unit (TCR Parameter)

You can change the unit, (cm or inch) of time correction.

Setting item: TCR Parameter

Setting contents:

cm (Initial setting) / inch

cm:

Time correction value is in centimetres.

inch:

Time correction value is in inches.

Adjusting the Time Correction (T.Correction)

Before performing the following procedures, refer to “About Time Correction” on page 21.

- 1** After selecting T.Correction from the Audio Setup mode, turn the **Rotary encoder** to select a speaker to be adjusted, and then press **Q/ENTER**.

F-L*1 ↔ F-R*2 ↔ R-L*3 ↔ R-R*4 ↔ SW-L ↔ SW-R

*1 Front-L

*2 Front -R

*3 Rear-L

*4 Rear-R

- 2** Turn the **Rotary encoder** to adjust the distance of the selected speaker, and then press **Q/ENTER**.

0.0 cm to 336.6 cm (3.4 cm/step)

0.0 inch to 132.7 inch (1.3 inch/step)

Note

- The total adjustment distance for all speakers should be less than 510 centimetres (201 inches).

- 3** Repeat steps 1 and 2 to set another speaker.

By setting these values to make its sound reach the listening position at the same time as the sound of other speakers.

Adjusting the SPATIAL

This function allows you to change the sound field easily.

There are three modes to choose from. For details, refer to the table below.

Mode	Effect
OFF (Initial setting)	No effect is applied. OFF status
Front Wide	Creates the effect of widening the front sound field by delaying the sound of the front speakers.
Rear Wide	Creates the effect of making the front sound image clear and far by delaying the sound of the rear speakers.

Adjusting the Crossover Settings (X-Over)

Before performing the following procedures, refer to “About the Crossover” on page 22.

- 1** After selecting X-Over from the Audio Setup mode, turn the **Rotary encoder** to select the desired channel, and then press **Q/ENTER**.
- 2** Turn the **Rotary encoder** to select the desired frequency within the selected channel, and then press **Q/ENTER**.
- 3** Repeat step 2 to adjust the slope and Level within the selected channel.

Adjusting the Channel (Ch.)

Setting contents:

Front (HPF) / Rear (HPF) / SUBW (LPF)

Selecting the Cut-Off Frequency (Freq.)

Setting contents:

20 / 25 / 31.5 / 40 / 50 / 63 / 80 (Initial setting) / 100 / 125 / 160 / 200 (Hz)

Adjusting the Slope

Setting contents:

Flat (Initial setting) / 6 / 12 / 18 / 24 dB/oct.

Adjusting the Level (Lev.)

Setting contents:

-12 to 0 (dB) (Initial setting: 0)

Storing the Parametric EQ/T.Correction/X-Over Settings

The Parametric EQ/T.Correction and X-Over settings can be stored in the preset memory.

- 1** The Parametric EQ/T.Correction/X-OVER settings can be stored in any one of the **preset buttons(1 through 6)**. After completing any adjustment for Parametric EQ/T.Correction/X-OVER (e.g. Band), press and hold the desired preset button for at least 2 seconds.
- 2** Turn the **Rotary encoder** to select Protect YES/NO, and then press **Q/ENTER** to store the adjusted contents.
Protect NO ↔ Protect YES (Initial setting)

Notes

- If Protect YES is selected, the adjusted contents are protected and stored into the preset buttons. When you want to store the parameter into a protected preset button, “Replace NO/YES” can be selected. If Protect NO is selected, the preset is stored.
- While perform this operation, all adjusted contents of Parametric EQ/T.Correction and X-Over will be stored in the preset buttons.
- The stored contents are not deleted even when resetting the unit or disconnecting the battery.
- The stored contents can be recalled by performing operation (refer to “Recalling the Stored Parametric EQ/T.Correction/X-Over Settings” on page 21).

Recalling the Stored Parametric EQ/ T.Correction/X-Over Settings

The stored Parametric EQ/T.Correction and X-Over settings are stored in the preset memory.

- 1 After selecting any item of the Parametric EQ/T.Correction/X-Over mode (e.g. Band), press any one of the preset buttons (1 through 6) that has your desired characteristic in memory to recall the stored settings.

The adjusted contents of Parametric EQ/T.Correction/X-Over stored into the preset button will be demonstrated.

- 2 Press the preset button again during the demonstration to recall the stored settings.

About Time Correction

The distance between the listener and the speakers in a car vary widely due to the complex speaker placement. This difference in the distances from the speakers to the listener creates a shift in the sounds image and frequency characteristics. This is caused by the time delay between the sound reaching the listener's right versus the left ear.

To correct this, this unit is able to delay the audio signal to the speakers closest to the listener. This effectively creates a perception of increased distance for those speakers. The listener can be placed at an equal distance between the left and right speakers for optimum staging. The adjustment will be made for each speaker in 3.4cm steps.

Listening Position example as follows:

Example 1: Front Left Seat

Adjust the time correction level of the front left speaker to a high value and the rear right to zero or a low value.

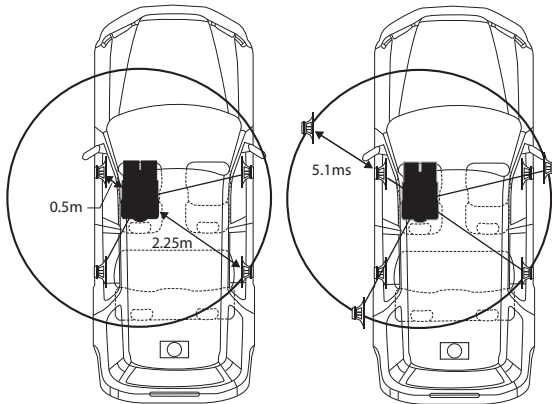

The sound is not balanced because the distance between the listening position and the various speakers is different.

The difference in distance between the front left speaker and the rear right speaker is 1.75 m (68-7/8").

Here we calculate the time correction value for the front left speaker in the diagram on the above.

Conditions:

Farthest Speaker - listening position : 2.25 m (88-9/16")

Front left speaker - listening position : 0.5 m (19-11/16")

Calculation: $L = 2.25 \text{ m} - 0.5 \text{ m} = 1.75 \text{ m}$ (68-7/8")

Time correction = $1.75 \div 343^* \times 1,000 = 5.1 \text{ (ms)}$

* Speed of sound: 343 m/s (765 mph) at 20°C

In other words, giving the front left speaker a time correction value of 5.1 ms makes it seem as if its distance from the listener is the same as the distance to the farthest speaker.

Time correction eliminates the differences in the time required for the sound to reach the listening position.

The time of the front left speaker is corrected by 5.1 ms so that its sound reaches the listening position at the same time as the sound of other speakers.

Example 2: All Seats

Adjust the time correction level of each speaker to almost the same level.

- 1 Sit in the listening position (driver's seat, etc.) and measure the distance (in metres) between your head and the various speakers.

- 2 Calculate the difference between the distance correction value to the farthest speaker and the other speakers.

$$L = (\text{distance to farthest speaker}) - (\text{distance to other speakers})$$

These values are the time correction values for the different speakers. Setting these values to make each sound reach the listening position at the same time as the sound of other speakers.

Time Correction Value List

Delay Number	Time Difference (ms)	Distance (cm)	Distance (inch)
0	0.0	0.0	0.0
1	0.1	3.4	1.3
2	0.2	6.8	2.7
3	0.3	10.2	4.0
4	0.4	13.6	5.4
5	0.5	17.0	6.7
6	0.6	20.4	8.0
7	0.7	23.8	9.4
8	0.8	27.2	10.7
9	0.9	30.6	12.1
10	1.0	34.0	13.4
11	1.1	37.4	14.7
12	1.2	40.8	16.1
13	1.3	44.2	17.4
14	1.4	47.6	18.8
15	1.5	51.0	20.1
16	1.6	54.4	21.4
17	1.7	57.8	22.8
18	1.8	61.2	24.1
19	1.9	64.6	25.5
20	2.0	68.0	26.8
21	2.1	71.4	28.1
22	2.2	74.8	29.5
23	2.3	78.2	30.8
24	2.4	81.6	32.2
25	2.5	85.0	33.5
26	2.6	88.4	34.8
27	2.7	91.8	36.2
28	2.8	95.2	37.5
29	2.9	98.6	38.9

Delay Number	Time Difference (ms)	Distance (cm)	Distance (inch)
30	3.0	102.0	40.2
31	3.1	105.4	41.5
32	3.2	108.8	42.9
33	3.3	112.2	44.2
34	3.4	115.6	45.6
35	3.5	119.0	46.9
36	3.6	122.4	48.2
37	3.7	125.8	49.6
38	3.8	129.2	50.9
39	3.9	132.6	52.3
40	4.0	136.0	53.6
41	4.1	139.4	54.9
42	4.2	142.8	56.3
43	4.3	146.2	57.6
44	4.4	149.6	59.0
45	4.5	153.0	60.3
46	4.6	156.4	61.6
47	4.7	159.8	63.0
48	4.8	163.2	64.3
49	4.9	166.6	65.7
50	5.0	170.0	67.0
51	5.1	173.4	68.3
52	5.2	176.8	69.7
53	5.3	180.2	71.0
54	5.4	183.6	72.4
55	5.5	187.0	73.7
56	5.6	190.4	75.0
57	5.7	193.8	76.4
58	5.8	197.2	77.7
59	5.9	200.6	79.1
60	6.0	204.0	80.4
61	6.1	207.4	81.7
62	6.2	210.8	83.1
63	6.3	214.2	84.4
64	6.4	217.6	85.8
65	6.5	221.0	87.1
66	6.6	224.4	88.4
67	6.7	227.8	89.8
68	6.8	231.2	91.1
69	6.9	234.6	92.5
70	7.0	238.0	93.8
71	7.1	241.4	95.1
72	7.2	244.8	96.5
73	7.3	248.2	97.8
74	7.4	251.6	99.2
75	7.5	255.0	100.5
76	7.6	258.4	101.8
77	7.7	261.8	103.2
78	7.8	265.2	104.5
79	7.9	268.6	105.9

Delay Number	Time Difference (ms)	Distance (cm)	Distance (inch)
80	8.0	272.0	107.2
81	8.1	275.4	108.5
82	8.2	278.8	109.9
83	8.3	282.2	111.2
84	8.4	285.6	112.6
85	8.5	289.0	113.9
86	8.6	292.4	115.2
87	8.7	295.8	116.6
88	8.8	299.2	117.9
89	8.9	302.6	119.3
90	9.0	306.0	120.6
91	9.1	309.4	121.9
92	9.2	312.8	123.3
93	9.3	316.2	124.6
94	9.4	319.6	126.0
95	9.5	323.0	127.3
96	9.6	326.4	128.6
97	9.7	329.8	130.0
98	9.8	333.2	131.3
99	9.9	336.6	132.7

About the Crossover

Crossover (X-Over):

This unit is equipped with an active crossover. The crossover limits the frequencies delivered to the outputs. Each channel is controlled independently. Thus, each speaker pair can be driven by the frequencies for which they have been optimally designed.

The crossover adjusts the HPF (high pass filter) or LPF (low pass filter) of each band, and also the slope (how fast the filter rolls off the highs or lows).

Adjustments should be made according to the reproduction characteristics of the speakers. Depending on the speakers, a passive network may not be necessary. If you are unsure about this point, consult your authorized Alpine dealer.

	Cut-off frequency (1/3 octave steps)		Slope		Level
	HPF	LPF	HPF	LPF	
Low range speaker	----	20 Hz - 200 Hz	----	Flat, 6, 12, 18, 24 dB/oct.	0 to -12 dB
Rear high range speaker	20 Hz - 200 Hz	----	Flat, 6, 12, 18, 24 dB/oct.	----	0 to -12 dB
Front high range speaker	20 Hz - 200 Hz	----	Flat, 6, 12, 18, 24 dB/oct.	----	0 to -12 dB

Other Functions

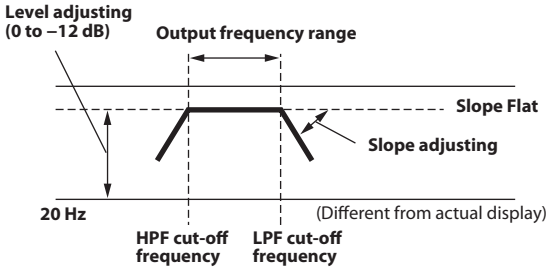
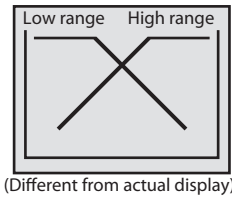

Notes

- **HPF (high pass filter):** Cuts the lower frequencies and allows the higher frequencies to pass.
 - **LPF (low pass filter):** Cuts the higher frequencies and allows the lower frequencies to pass.
 - **Slope:** The level change (in dB) for a frequency change of one octave.
 - The higher the slope value, the steeper the slope becomes.
 - Adjust the slope to Flat to bypass the HP or LP filters.
 - Do not use a tweeter without the HPF on or set to a low frequency, as it may cause damage to the speaker due to the low frequency content.
 - You cannot adjust the crossover frequency higher than the HPF or lower than the LPF.
 - Adjustment should be made according to the recommended crossover frequency of the connected speakers. Determine the recommended crossover frequency of the speakers. Adjusting to a frequency range outside that recommended may cause damage to the speakers. For the recommended crossover frequencies of Alpine speakers, refer to the respective Owner's Manual.
- We are not responsible for damage or malfunction of speakers caused by using the crossover outside the recommended value.

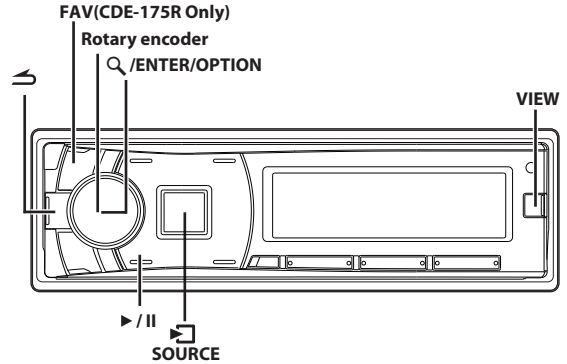

Displaying the Text

Text information, such as the disc name and the track name, will be displayed if playing a CD text compatible disc. It is also possible to display the folder name, the file name and the tag, etc. while playing MP3/WMA/AAC files.

Press VIEW.

The display will change every time the button is pressed.

Note

- When the Text Scroll is set to Manual (refer to "Scroll Setting (Text Scroll)" on page 29), press and hold **VIEW** for at least 2 seconds, the current text will be scrolled one time (except Radio mode).

The display in Radio mode:

If there is PS (Programme Service Name)

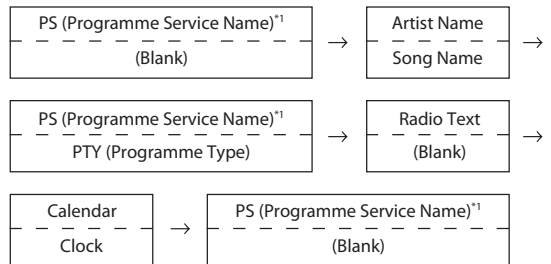

If there is no PS (Programme Service Name)

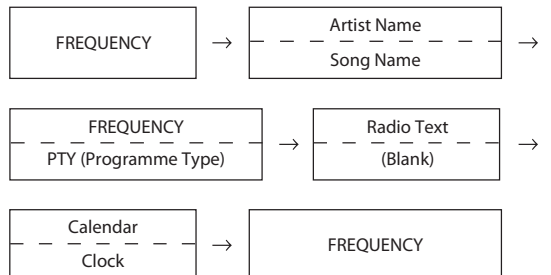

The display in CD mode:

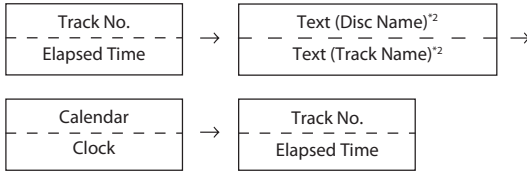

The display in MP3/WMA/AAC mode:

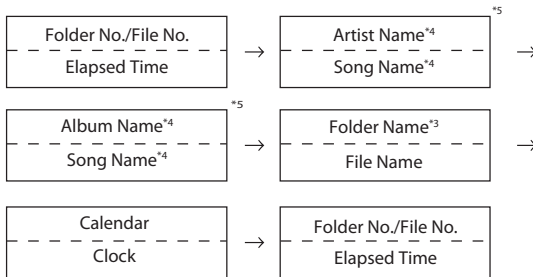

The display in iPod/iPhone mode:

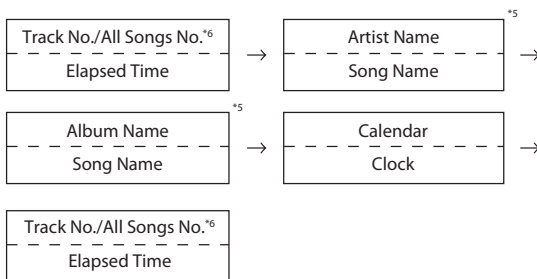

The display in BLUETOOTH Audio mode:

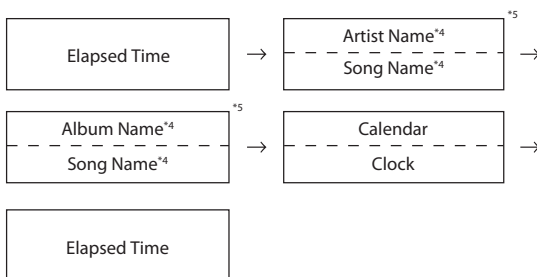

The display in vTuner mode:

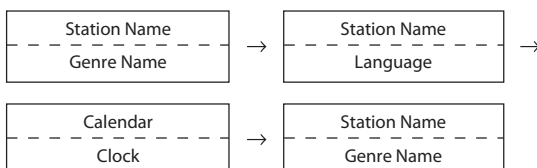

- *1 Press and hold **VIEW** for at least 2 seconds if PS is displayed in the radio mode, frequency will be displayed for 5 seconds.
- *2 Displayed during playback of a disc with CD Text. If there is no text information, nothing will be displayed.
- *3 The root folder of disc/USB Memory is displayed as “\ROOT”. If there is no text information, nothing will be displayed.
- *4 If an MP3/WMA/AAC file contains ID3 tag/WMA tag information, the ID3 tag/WMA tag information is displayed (e.g., song name, artist name, and album name). All other tag data is ignored. If there is no text information, nothing will be displayed.
- *5 When the Text Scroll (refer to “Scroll Setting (Text Scroll)” on page 29) is set to “Auto”, the display cannot be switched by pressing **VIEW**. The display contents switch alternately.
- *6 The numbers of all songs displayed vary depending on the songs selected by the search.

About the indication display

When displaying Text, the following indicators are lit according to the mode.

Indicator/Mode	Radio Mode	CD Mode	MP3/WMA/AAC Mode	iPod/iPhone/BLUETOOTH Audio Mode
	—	—	Folder Name being displayed	—
	Artist Name being displayed	—	Artist Name being displayed	Artist Name being displayed
	—	—	Album Name being displayed	Album Name being displayed
	—	—	File Name being displayed	—
	—	Text (Disc Name) being displayed	—	—
	Song Name being displayed	Text (Track Name) being displayed	Song Name being displayed	Song Name being displayed
	Text (Radio Name) being displayed	—	—	—

Indicator/Mode	vTuner Mode
	Station Name being displayed
	Genre Name being displayed
	Language being displayed

About “Text”

Text compatible CDs contain text information such as the disc name and track name. Such text information is referred to as “text”.

Notes

- Some characters may not be displayed correctly with this device, depending on the character type.
- If there is no TEXT information, the display is blank.
- The text or tag information may not be correctly displayed, depending on the contents.

Setting your favourite source to the FAV button (FAV Setup) (CDE-175R only)

You can set a favourite source to the FAV button by following steps. Once this is set, you can switch to favourite source directly by pressing **FAV**.

Set your favourite source

- 1 Press and hold **FAV** for at least 2 seconds to activate **FAV setup mode**.
- 2 Turn the **Rotary encoder** to select a favourite source, and then press **Q / ENTER**.
The favourite source is set.
OFF ↔ FM1 ↔ FM2 ↔ FM3 ↔ MW ↔ LW ↔ Disc ↔ USB/iPod ↔ vTuner ↔ AUX

Notes

- You can also set the favourite source in **SETUP mode**, refer to “Setting your favourite source to the FAV button (FAV Setup) (CDE-175R only)” on page 28.
- If you do not want to use this function, select “OFF”.
- If no operation is performed for 10 seconds, the unit automatically returns to normal mode.
- Pressing **↶** will return to normal mode.

Recall your favourite source

Once a source is set to **FAV** button, press **FAV** to recall the source directly.

Note

- Depending on the setting, even though you set a source to **FAV**, it may not be available. For example, when you set **AUX** as your favourite source and **OFF** is set in “Setting the **AUX SETUP Mode**” (refer to “Setting the **AUX SETUP mode**” on page 28), the **AUX** source will not be recalled by pressing **FAV**.

Option Menu Setting

You can quickly adjust the setting items relevant to the current **SOURCE** by using **Option Menu**.

- 1 Press and hold **Q / ENTER / OPTION** for at least 2 seconds to activate the **Option menu of the current source**.

Note

- The option menu varies depending on the source.

- 2 Turn the **Rotary encoder** to select the desired setting item, and then press **Q / ENTER**.
- 3 Turn the **Rotary encoder** to change the setting, and then press **Q / ENTER**.

After the setting, the display will return to the current source automatically.

The following setting items are displayed when **Language Setup** is set to **English**. For details, refer to “Setting the **Menu Language**” on page 28.

Setting item:

TUNER mode:

PTY Select*1 ↔ Tuner Setup*2 ↔ VOL LV ADJ*3 ↔ Dimmer*4 ↔ PTY Select

DISC mode (CDE-178BT/CDE-175R only):

CD Setup*5 ↔ VOL LV ADJ*3 ↔ MX Setup*6 ↔ Dimmer*4 ↔ CD Setup

USB mode:

USB Setup*7 ↔ VOL LV ADJ*3 ↔ MX Setup*6 ↔ Dimmer*4 ↔ USB Setup

iPod mode:

APP Direct*8 ↔ iPod Setup*9 ↔ VOL LV ADJ*3 ↔ MX Setup*6 ↔ Dimmer*4 ↔ APP Direct

AUX mode:

AUX Setup*10 ↔ VOL LV ADJ*3 ↔ MX Setup*6 ↔ Dimmer*4 ↔ AUX Setup

vTuner mode:

VOL LV ADJ*3 ↔ MX Setup*6 ↔ Dimmer*4 ↔ VOL LV ADJ

BT Audio mode (CDE-178BT/iDE-178BT only):

BT Setup*11 ↔ VOL LV ADJ*3 ↔ MX Setup*6 ↔ Dimmer*4 ↔ BT Setup

Phone mode (Non-calling mode) (CDE-178BT/iDE-178BT only):

Phone Setup*12 ↔ VOL LV ADJ*13 ↔ Dimmer*4 ↔ Phone Setup

Phone mode (Calling mode) (CDE-178BT/iDE-178BT only):

MIC Gain*14 ↔ Call Sound*14 ↔ Speak Switch*15 ↔ Voice Mute*16 ↔ Call Wait*17 ↔ END Call*18 ↔ VOL LV ADJ*13 ↔ Dimmer*4 ↔ MIC Gain

*1 Refer to “PTY (Programme Type) Tuning” on page 13.

*2 The setting items are the same as **Tuner** setting in **SETUP mode**. For details, refer to “**SETUP**” on page 27.

*3 You can individually emphasise or weaken the volume level of the current source to create your own tonal preference. The setting values in **Option mode** and in **SETUP mode** are linkage. Refer to “Setting the **Source Volume Level**” on page 18.

*4 Refer to “**Dimmer Control**” on page 29.

*5 **Play Mode** can be selected in this mode. For details, refer to “**Playing MP3/WMA/AAC Data (Play Mode) (CDE-178BT/CDE-175R only)**” on page 28.

*6 Refer to “**Setting the Media Xpander mode (MX Setup)**” on page 19.

*7 **USB Skip** can be selected in this mode. For details, refer to “**Setting the USB Skip function**” on page 30.

*8 Refer to “**Setting the iPod Control**” on page 39.

*9 **iPod List Setup** can be selected in this mode. For details, refer to “**iPod/iPhone Search Mode Setting**” on page 30.

*10 **AUX Name** can be selected in this mode. For details, refer to “**Setting the AUX NAME mode**” on page 28.

*11 **FW Version** can be selected in this mode. You can see the current firmware version about **BLUETOOTH** by using this setting.

*12 **Call Sound, Caller ID, PB Update, PB Order, Auto Answer, Service Name, Speaker Select and FW Version** can be selected in this mode. For details about these settings, refer to “**BLUETOOTH SETUP**” on page 32.

*13 The **Hands free phone talk level, ring tone level and microphone gain level** can be adjusted by using this setting. Changing the settings in the **Option mode** will also affect the same settings in the **SETUP menu**. Refer to “**Adjusting the volume (VOL LV ADJ)**” on page 33.

*14 Refer to “**Setting the BLUETOOTH sound quality**” on page 33.

- *15 While calling, the call sound can be switched between the unit and Smartphone by using this setting. This operation can also be done by pressing **BAND**. Refer to “Call Switching Operation” on page 36.
- *16 While calling, and the Voice Mute is activated, the microphone input will mute instantly and “VOICE MUTE” will blink. This operation can also be done by pressing **▶/||**. Refer to “Muting the microphone input quickly (Voice Mute)” on page 36.
- *17 If there is a waiting call, select this item to display the caller’s Name and waiting number (1 or 2). Press **VIEW** and the display will switch.
- *18 Select this item to hang up the call.

Notes

- Press **↶** to return to the previous mode.
- If no operation is performed for 60 seconds, the unit will return to normal mode automatically.

Applying Tunelt

This unit’s sound tuning is programmable from a connected Smartphone. It is also possible to download specific parameters for certain vehicles from Alpine’s TuneIt database stored in the Cloud. Using the TuneIt App, customized parameters can also be uploaded for others to share and rate.

Through this unit, it is also possible to receive and respond to information from Alpine’s Social Network Service (SNS) available through the connected Smartphone.

The installed TuneIt App should be launched on the Smartphone before connection to the head unit.

TuneIt, is downloadable from Apple’s App Store; the Android user can download it from Google Play. For details, consult your Alpine dealer. Before these operations, set Alpine APP to USB or BT depending on the connected Smartphone. For details, refer to “Setting the communication mode with a Smartphone (Alpine APP)” on page 30.

Notes

- For CDE-175R, only the iPhone can be connected to the unit.
- The application programme and related specifications and data may be deleted or terminated without notice.
- Some TuneIt functions may not be available if the Smartphone is not in a service area or receives no signal.

Adjusting the sound via Smartphone

After the above procedure, you can adjust the unit’s sound function on the Smartphone.

- 1 **Make sure the unit is powered on.**
- 2 **Launch the TuneIt App on the Smartphone. Adjust the unit’s sound accordingly on the Smartphone.**
During sound setting, **▶/||**/SOURCE key may blink.

Notes

- Volume and sound parameter preset function cannot be adjusted via Smartphone.
- The setting cannot be done on both the Smartphone and this unit at the same time. While the sound function of this unit is set via the Smartphone, sound function settings on CDE-178BT/iDE-178BT/CDE-175R will be displayed as “APP Connect”.
- When the unit is powered off or during a call, sound setting cannot be done via the Smartphone.
- This function may not be available depending on the paired Smartphone.
- Please obey all local traffic laws while using this function.

Facebook Notification Function

Some functions may be available in a future version of TuneIt.

Note

- Depending on the paired Smartphone, the follows functions may not available even though the TuneIt version is updated.

Receiving Notification (Ready on future update)

When the Smartphone connected to this unit receives notification from Facebook, it will BEEP and the **▶/||**/SOURCE key blinks (depending on the TuneIt settings on the phone). At the same time, the user’s name is shown in the display (20 characters maximum).

- 1 **While receiving Notification from Facebook, press **▶/||**/SOURCE button.**

Notification Menu screen is displayed.

- 2 **Turn the Rotary encoder to select the desired mode, and then press **Q**/ENTER.**

Like^{*1} ↔ Replay ↔ Next ↔ Previous ↔ TTS Volume^{*2} ↔ Like

*1 Not displayed only when the received Notification is Message type.

*2 It can also be set in SETUP section. For details, refer to “Setting the TTS (Text To Speech) volume” on page 30.

Like:	The Smartphone feedbacks to Facebook with “Like”, and meanwhile, the received Wall Posts or Comments is played back by TTS (Text To Speech).
Replay:	To play back Notification by TTS (Text To Speech) again.
Next:	To select the next Notification.
Previous:	To select the previous Notification.
TTS Volume:	To adjust the playback volume of TTS (Text To Speech).

Notes

- Press **↶** to return to the previous mode.
- A new received Notification prompt will last for 30 seconds. If there is no operation within 30 seconds, the unit will return to normal mode.
- When this unit is powered off, during a call or receiving RDS interruption information, Notification of Smartphone will not be prompted by this unit.

Displaying Notification List (Ready on future update)

You can view the received Notification from Facebook in the connected Smartphone via this unit.

- 1 **Press and hold **▶/||**/SOURCE for at least 2 seconds.**
The received Notification will be displayed according to when it was posted.
- 2 **Turn the Rotary encoder to select the desired Notification, and then press **Q**/ENTER.**
- 3 **Then go to step 2 of “Receiving Notification”.**

Notes

- When there is no Notification, “No Notification” will be displayed.
- The displayable amount of the Notification list depends on the connected Smartphone.

SETUP

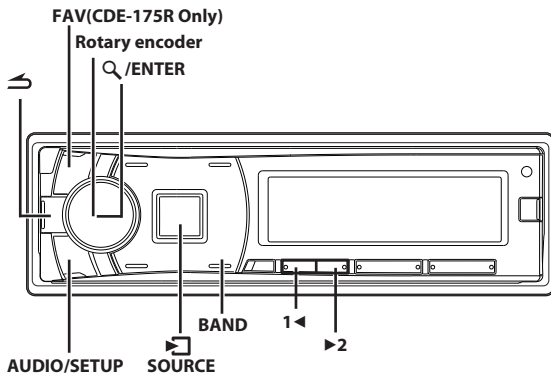

Setting

You can flexibly customize the unit to suit your own preferences and usage. From the SETUP menu, General Setting, Display Setting, etc. can be modified.

Use steps 1 to 5 to select one of the SETUP modes to modify. See the applicable section below for details about the selected SETUP item.

- 1** Press and hold **AUDIO/SETUP** for at least 2 seconds to activate the SETUP mode.
- 2** Turn the **Rotary encoder** to select the desired item, and then press **Q/ENTER**.
Audio^{*1} ↔ General ↔ Display ↔ Tuner ↔ iPod&USB ↔ Application ↔ Bluetooth^{*2} ↔ Audio
- 3** Turn the **Rotary encoder** to select a setting item, and then press **Q/ENTER**.

General:

Clock Mode ↔ Auto Clock ↔ Clock Adjust^{*3} ↔ Calendar ↔ FAV Setup^{*4} ↔ Language Setup ↔ AUX IN ↔ AUX Name^{*5} ↔ Play Mode^{*6} ↔ Beep ↔ Demo ↔ Steering ↔ Clock Mode

Display:

Illumination ↔ Dimmer ↔ Dimmer Level ↔ Scroll Type ↔ Text Scroll ↔ Opening MSG ↔ Illumination

Tuner:

AF^{*7} ↔ News^{*8} ↔ Alert PTY31^{*9} ↔ RDS Regional^{*10} ↔ PI Seek^{*11} ↔ FM Tuner Setup ↔ AF

iPod&USB:

USB Skip ↔ iPod List Setup ↔ USB Skip

Application:

Alpine APP ↔ TTS Volume ↔ Alpine APP

- *1 Refer to "Audio Setup" on page 18.
- *2 Refer to "BLUETOOTH SETUP" on page 32. Only for CDE-178BT/iDE-178BT.
- *3 Refer to "Setting the Time and Calendar" on page 10.
- *4 Only for CDE-175R.
- *5 Displayed only when AUX IN is ON.
- *6 Only for CDE-178BT/CDE-175R.
- *7 Refer to "Turning AF (Alternative Frequencies) ON/OFF" on page 12.
- *8 Refer to "Priority News" on page 12.

- *9 Refer to "Setting PTY31 (Emergency Broadcast) reception" on page 12.
- *10 Refer to "Receiving RDS Regional (Local) Stations" on page 13.
- *11 Refer to "PI SEEK Setting" on page 13.

- 4** Turn the **Rotary encoder** to change the setting, and then press **Q/ENTER**.
- 5** Press and hold **AUDIO/SETUP** for at least 2 seconds to return to normal mode.

Notes

- Pressing **↶** returns to the previous SETUP mode.
- If no operation is performed for 60 seconds, SETUP is cancelled.

General Setting

General is selected on the setup main menu in step 2.

Setting the Clock Display (Clock Mode)

You can select the clock display type, 12-hour or 24-hour, depending on your preference.

Setting item: Clock Mode

Setting contents:

00:00 (24-hour) (Initial setting) / AM (Before noon) 12:00 (12-hour)

Setting the Time to automatically be adjusted

When ON is selected, the clock is adjusted automatically based on the time data sent from the RDS broadcast.

Setting item: Auto Clock

Setting contents:

OFF / ON (Initial setting)

OFF:

To adjust it manually.

ON:

Adjust the clock automatically based on the time data.

Setting of Calendar Display Pattern Switching (Calendar)

You can switch the calendar display pattern to be shown when the time is displayed.

Setting item: Calendar

Setting contents:

mm/dd/yyyy / dd/mm/yyyy (Initial setting) / yyyy/mm/dd

yyyy:

Shows the year

mm:

Shows the month

dd:

Shows the day

ex. dd/mm/yyyy → 01/01/2013

Setting your favourite source to the FAV button (FAV Setup) (CDE-175R only)

You can select one source as your favourite source. Once this is set, you can switch to favourite source directly by pressing **FAV**.

■ Setting item: FAV Setup

Setting contents:

OFF (Initial setting) / FM1 / FM2 / FM3 / MW / LW / Disc / USB/iPod / vTuner / AUX

Notes

- Depending on the setting, some item may not selectable.
- If you do not want to use this function, select "OFF".
- This setting can also be activated by pressing and holding **FAV** for at least 2 seconds. For details, refer to "Setting your favourite source to the FAV button (FAV Setup) (CDE-175R only)" on page 25.

Setting the Menu Language

Set the language to be displayed on the unit. Six types of font can be selected.

■ Setting item: Language Setup

Setting contents:

English (Initial setting) / Russian / Deutsch / Francais / Espanol / Italiano / Nederlands

Note

- The Owner's Manual only describes the setup menu display when English is set.

Setting the AUX SETUP mode

You can input the audio of an external device, (such as a Portable audio player) to the AUX connector of this unit.

■ Setting item: AUX IN

Setting contents:

OFF / ON (Initial setting)

OFF:

When set to OFF, AUX source cannot be selected.

ON:

Set to ON when a portable device is connected. If /SOURCE is pressed and AUX is selected, the sound of the portable device is input to the unit.

Setting the AUX NAME mode

You can change the AUX NAME display in the SETUP mode.

■ Setting item: AUX Name

Setting contents:

Auxiliary (Initial setting) / TV / DVD / Portable / Game

Playing MP3/WMA/AAC Data (Play Mode) (CDE-178BT/CDE-175R only)

This unit can play back CDs containing both CD and MP3/WMA/AAC data (created in Enhanced CD (CD Extra) format). However, in some situations, playback of an enhanced CD may be difficult. In this case, you can select playback of a single session only, containing the CD data. When a disc contains both CD and MP3/WMA/AAC data, playback starts from the CD data portion of the disc.

■ Setting item: Play Mode

Setting contents:

CD-DA / CDDA&MP3/WMA (Initial setting)

CD-DA:

Only the CD data in Session 1 can be played back.

CDDA&MP3/WMA:

CD data, MP3/WMA/AAC files in mixed mode, and multi-session discs can be played back.

Note

- Perform this setting before inserting a disc. If a disc has already been inserted, remove it first.

Sound (Beep) Guide Function

This function will give audible feedback with varying tones depending upon the button pressed.

■ Setting item: Beep

Setting contents:

OFF / Level 1~7

Note

- The initial setting is Level 4.

Demonstration

This unit has a demonstration feature for the display.

■ Setting item: Demo

Setting contents:

OFF (Initial setting) / ON

Note

- To quit Demo mode, set to Demo OFF.

Setting Adaptive Steering Remote Control

This unit is compatible with the adaptive steering remote control. This function allows operation by sending the steering remote control signal to the unit.

To use the steering remote control, perform the following button operations after setting to ON and pressing **Q/ENTER**.

For details, consult your nearest Alpine dealer.

■ Setting item: Steering

Setting contents:

OFF (Initial setting) / ON

1 Select the assigned function by turning the Rotary encoder.

(e.g. Select SOURCE)

POWER ↔ SOURCE ↔ BAND ↔ VOL. UP ↔ VOL. DN ↔ PAUSE ↔ MUTE ↔ BWD ↔ FWD ↔ P. UP ↔ P. DN ↔ POWER



FF SOURCE FF

2 Press the steering remote control button until the changed signal value of steering remote control appears in the left of the display.

(e.g. Press SOURCE of the steering remote control button.)

The changed steering remote control signal appears in the left of the display.



DE SOURCE FF

The changed signal value of steering remote control

3 Press **Q/ENTER** to execute the setting value.

The confirmed signal value of steering remote control appears in the right of the display. With doing so, the function of the unit is assigned to the steering remote control button.



DE SOURCE DE

The confirmed signal value of steering remote control

4 Repeat steps 1 to 3, and set each button.

When settings have been completed, press **↶** to return to the previous mode.

Display Setting

Display is selected on the setup main menu in step 2.

Changing Lighting Colour

You can change the lighting colour of the unit's buttons.

■ Setting item: Illumination

Setting contents:

TYPE1 (Initial setting) / TYPE2 / TYPE3 / TYPE4

TYPE1 :

The colour of all buttons is blue.

TYPE2 :

The colour of all buttons is green.

TYPE3 :

The colour of all buttons is amber.

TYPE4 :

The colour of all buttons is red.

Dimmer Control

Set the Dimmer control to Auto to decrease the illumination brightness of the unit with the head lights of the vehicle ON. This mode is useful if you feel the unit's backlighting is too bright at night.

■ Setting item: Dimmer

Setting contents:

Auto / ON (Initial setting) / OFF

Dimmer Level Setting

In the Dimmer Level setting, three levels are available, the highest level (Level3) being the dimmest when the car headlights are on.

■ Setting item: Dimmer Level

Setting contents:

Level 1 (Initial setting) / Level 2 / Level 3

Scroll Type Setting

Choose from two scrolling methods.

Select the type you prefer.

■ Setting item: Scroll Type

Setting contents:

TYPE 1 (Initial setting) / TYPE 2

TYPE 1 :

The characters scroll from right to left, one character at a time, until the entire title has scrolled.

TYPE 2 :

Words are built up from left to right, a single character at a time. When the display is full, it is cleared and the subsequent words are displayed the same way until all words of the title have been shown.

Scroll Setting (Text Scroll)

This CD player can scroll the disc and track names recorded on CD-TEXT discs, as well as the text information of MP3/WMA/AAC files, folder names, and tags.

■ Setting item: Text Scroll

Setting contents:

Manual (Initial setting) / Auto

Manual:

The above information is scrolled only when a disc is loaded, a channel or track is changed, etc.

Auto:

CD text information, folder and file names, and the tag information are scrolled continuously.

Note

- In parts of the display, scrolling may not occur, or scroll content may differ.

Opening Message ON/OFF Setting

This unit includes a special message feature with various patterns, which when enabled displays opening messages for certain occasions. For example, when you turn this unit on December 25th (according to the unit's date setting), a Christmas greeting is displayed if the Opening Message is set to ON.

Setting item: Opening MSG**Setting contents:**

OFF (Initial setting) / ON

Tuner Setting

Tuner is selected on the setup main menu in step 2.

Setting the TUNER (FM) tone quality

This unit can set your preferred tone quality for FM radio source.

Setting item: FM Tuner Setup**Setting contents:**

Hi-Fi / Normal (Initial setting) / Stable

Hi-Fi:

High-quality setting

Normal:

Standard setting

Stable:

Control noise

Note

- Noise may be more noticeable when Hi-Fi is set, depending on the reception status. In this case, the Normal setting is recommended.

iPod&USB Setting

iPod&USB is selected on the setup main menu in step 2.

Setting the USB Skip function

During searching, you can skip over designated folders/files by pressing and holding **1** ◀/▶ **2** for at least 2 seconds. For example, if you select 10File in the searching mode, by pressing and holding **1** ◀ you can skip backward 10 folders/files from the current folder/file; by pressing and holding ▶ **2** you can skip forward 10 folders/files from the current folder/file. If the folders/files searched are less than the assigned skipped-over ones, pressing and holding **1** ◀/▶ **2** will skip to the first or last folder/file.

Setting item: USB Skip**Setting contents:**

10File (Initial setting) / 20File / 50File / 100File

iPod/iPhone Search Mode Setting

The unit allows you to search for the iPod/iPhone using nine different search modes.

Setting item: iPod List Setup**Further setting items:** Playlists / Artists / Albums /

Audiobooks / Podcasts / Genres / Composers / Songs / Genius Mixes

Setting contents:

OFF / ON

Notes

- When the search mode is in Playlists/Artists/Albums/Podcasts/Genres/Songs/Genius Mixes, the initial setting is On, and when the search mode is in Audiobooks/Composers, the initial setting is Off.
- For search mode details, refer to "Searching for a desired Song" on page 40.

Application Setting (APP)

Application is selected on the setup main menu in step 2.

Setting the communication mode with a Smartphone (Alpine APP)

Set Alpine APP to USB when an iPhone is connected, or set to BT when an Android Smartphone is paired.

Setting item: Alpine APP**Setting contents:**

OFF / USB (Initial setting) / BT*

* Only for CDE-178BT/iDE-178BT.

OFF:

No Smartphone is connected.

USB:

When an iPhone is connected to CDE-178BT/iDE-178BT/CDE-175R, you can enjoy vTuner program the unit's sound tuning parameters, or communicate with SNS.

BT:

Set this when an Android Smartphone is paired with this unit via BLUETOOTH technology. At this time, you can program the unit's sound tuning parameters, or communicate with SNS.

Notes

- After the above setting, turn the ignition key off (ACC OFF) and on again (ACC ON).
- For this function to work properly, specific applications must be installed on your Smartphone before connection. Consult your Alpine dealer or the Alpine web site for details.
- Only the iPhone and certain Android Smartphones support this function.

Setting the TTS (Text To Speech) volume

This function allows for readout of comments, etc., on a Smartphone, and outputs sound from the speaker of the unit.

Setting item: TTS Volume**Setting contents:**

0~35

Note

- The initial volume level is 12.

BT Hands Free Calling (CDE-178BT/iDE-178BT only)

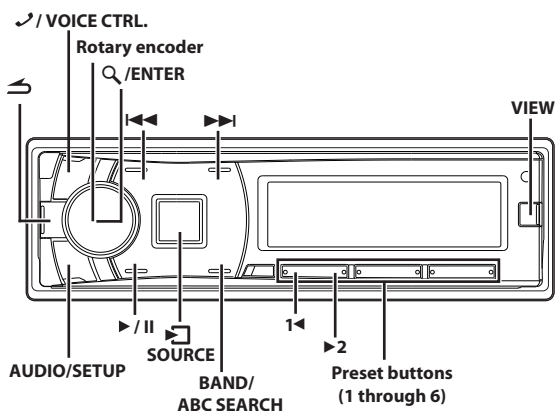

Setup Before Using

About BLUETOOTH

BLUETOOTH is a wireless technology allowing communication between a mobile device or personal computer over short distances. This enables a hands-free call or data transmission between BLUETOOTH compatible devices. BLUETOOTH transmission is available in the unlicensed 2.4 GHz spectrum if the distance between devices is within 10 metres. For details, refer to the BLUETOOTH Home page (<http://www.bluetooth.com>).

Notes

- Depending on the BLUETOOTH version, a BLUETOOTH compatible device may not be able to communicate with this unit.
- Proper function of this unit with all BLUETOOTH compatible devices is not guaranteed. For handling of the BT compatible device, consult your Alpine dealer or Alpine website.
- Depending on the surroundings, BLUETOOTH wireless connection may be unstable.
- When you place a call, or perform setup operations, be sure to stop your car in a safe place.
- Depending on the connected BLUETOOTH compatible device(s), the function may differ. Also refer to the Owner's Manual of the connected device(s).
- When you search for this unit using the BLUETOOTH compatible phone, the unit name is displayed as "Alpine CD Receiver"(CDE-178BT only)/"Alpine Digital Media Receiver"(iDE-178BT only).

Before Using BLUETOOTH Function

Before using the BLUETOOTH function, the following settings need to be made.

Set "Bluetooth IN" to ON when you want to use Hands-Free phone or Bluetooth Audio function. Refer to "Setting the BLUETOOTH Connection (Bluetooth IN)" on page 32.

Note

- Before using BLUETOOTH function, it must be paired with this unit. Refer to "How to connect to a BLUETOOTH compatible device (Pairing)" on page 31.

How to connect to a BLUETOOTH compatible device (Pairing)

For details on the control from a BLUETOOTH compatible device, refer to the Owner's Manual of the BLUETOOTH compatible device.

Pairing a BLUETOOTH compatible device with SSP (Secure Simple Pairing)

- 1 Using your BLUETOOTH compatible device, select the "Alpine CD Receiver"(CDE-178BT only)/"Alpine Digital Media Receiver"(iDE-178BT only) for pairing.
- 2 Turn the Rotary encoder to change the head unit display from "Pairing NO" to "Pairing YES", and then press Q/ENTER.
If "Pairing NO" is selected, the connection will be cancelled.
- 3 If the pairing was successful, "Connected" is displayed for a few seconds. The head unit then returns to its previous state.

Pairing a BLUETOOTH compatible device without SSP (Secure Simple Pairing)

- 1 Using your BLUETOOTH compatible device, select the "Alpine CD Receiver"(CDE-178BT only)/"Alpine Digital Media Receiver"(iDE-178BT only) for pairing.
- 2 Input the passcode ("0000") in a BLUETOOTH compatible device.
Note
 - The passcode is fixed as "0000".
- 3 If the pairing was successful, "Connected" is displayed for a few seconds. The head unit then returns to its previous state.

Notes

- If the connection is unsuccessful, "Failed" is displayed.
- After a successful pairing, the two devices should connect automatically whenever the vehicle's ignition is turned ON. If the auto connection fails, try to reconnect manually.
- Set "Visible Mode" to ON to enable this unit to be recognised by a BLUETOOTH compatible device, refer to "Setting the Visible Mode" on page 32.
- You can also manually pair the BLUETOOTH devices from this unit. For details, refer to "Pairing a BLUETOOTH Device from the unit" on page 32.

BLUETOOTH SETUP

The following steps 1 to 5 are common to the various BLUETOOTH functions. For details, refer to each individual function.

Note

- Set "Bluetooth IN" to ON, and then perform BLUETOOTH SETUP operation. Refer to "Setting the BLUETOOTH Connection (Bluetooth IN)" on page 32.

- Press and hold **AUDIO/SETUP** for at least 2 seconds to activate the SETUP mode.
- Turn the **Rotary encoder** to select "Bluetooth", and then press **Q/ENTER**.
The BLUETOOTH setup mode is activated.
- Turn the **Rotary encoder** to select the desired items and then press **Q/ENTER**.

BLUETOOTH:

Bluetooth IN^{*1} ↔ Paired Device^{*2} ↔ Visible Mode^{*1/*2} ↔ Search Device^{*1/*2} ↔ Call Sound^{*2} ↔ Caller ID^{*2} ↔ PB Update^{*1/*2} ↔ PB Order^{*2} ↔ Auto Answer^{*2} ↔ Service Name^{*2} ↔ Speaker Select^{*2} ↔ FW Version^{*2} ↔ FW Update^{*1/*2} ↔ Bluetooth IN

*1 The items are not displayed during a phone call.

*2 The items are not displayed if "Bluetooth IN" is set to OFF. Refer to "Setting the BLUETOOTH Connection (Bluetooth IN)" on page 32.

- Turn the **Rotary encoder** to change the settings.
- Press and hold **AUDIO/SETUP** for at least 2 seconds.
The SETUP mode is cancelled.

Notes

- Press **↶** to return to the previous mode.
- If no operation is performed for 60 seconds, the unit will return to normal mode automatically.

Setting the BLUETOOTH Connection (Bluetooth IN)

With BLUETOOTH technology, you can place a hands-free call by a BLUETOOTH-equipped Smartphone. Audio information of a BLUETOOTH compatible Smartphone, a portable audio player, etc., is controllable/playable wirelessly from this unit.

Setting item: Bluetooth IN

Setting contents:

OFF / ON (Initial setting)



OFF:

Hands-Free Phone ↔ function and Bluetooth Audio function are not used.

ON:

Select when you want to pair your BLUETOOTH compatible phone with this unit or use Bluetooth Audio function.

Note

- When BT IN is set to OFF, the indicators related to Hands-free phone ( battery charge and  signal strength) will not be displayed.









Setting the BLUETOOTH Device

Select one of 3 connected BLUETOOTH compatible devices that you previously registered.

Setting item: Paired Device

- Turn the **Rotary encoder** to select a BLUETOOTH compatible device you want to use (you want to change connection) and then press **Q/ENTER**.
- Turn the **Rotary encoder** to select "Connect" to connect the selected device.
The connected device is marked with "*". Select "Disconnect" to disconnect this device. Select "Clear" when you want to clear the device from the device list.

Notes

- If the connection is successfully changed, "Connected" is displayed for 2 seconds and the  indicator lights up, then the display returns to the SETUP screen.
- If a Smartphone is connected to this unit successfully, the  indicator lights up to show the battery charge of the connected Smartphone. The  indicator lights up when the battery charge is about 50%, the  indicator lights up when the battery charge is not enough, and it blinks as a low level warning. The  indicator goes out when the battery is drained. At this time, the BLUETOOTH function is unavailable due to the Smartphone powered off.
- Indicator  (Signal Strength):
The indicator will display the current signal strength of Smartphone. The  indicator goes out when the Smartphone is not in service area or receives no signal.
- Depending on the connected Smartphone, the  (battery charge) and  (signal strength) may not be displayed.
- If all the 3 positions have been registered, you cannot register the 4th device. To register another device, you need to delete one of the devices from position 1 to 3 first.

Setting the Visible Mode

You can set whether this unit can be recognised or not from a BLUETOOTH compatible device. Normally set this to ON.

Setting item: Visible Mode

Setting contents:

OFF / ON (Initial setting)

OFF:

Disable recognition of this unit from the BLUETOOTH compatible device.

ON:

Enable recognition of this unit from the BLUETOOTH compatible device.

Pairing a BLUETOOTH Device from the unit

If your BLUETOOTH device is not immediately pairing, the head unit can perform a search. The search can find paired or unpaired devices.

Setting item: Search Device

- When Search Device is selected and "Searching" is displayed, the search gets started.

Note

- The "Searching" operation can be stopped by pressing **↶**.

2 Turn the **Rotary encoder** to select the name of the device to be connected from the Device Search list and then press **Q/ENTER**.

3 If this unit is successfully connected to a **BLUETOOTH compatible device**, "Connected" is displayed, and then the unit returns to normal mode.

Depending on the Smartphone, it may be necessary to input a passcode. In this case, "Passcode 0000" is displayed. Input the passcode "0000" in the BLUETOOTH compatible device to make the pairing. After the pairing is completed, the unit will automatically connect to the BLUETOOTH compatible device. If you input the wrong passcode or the communication fails, "Failed" is displayed.

Setting the BLUETOOTH sound quality

You can flexibly customize the sound of a call to fit your own preferences.

■ **Setting item:** Call Sound

■ **Further setting items:** VOL LV ADJ / Type Setup

Adjusting the volume (VOL LV ADJ)

You can emphasize or weaken the volume level of the Phone call, the ring tone and the microphone input to fit your own preferences.

Setting contents:

Phone Talk:
-5 dB ~ +5 dB

Ring Tone:
-5 dB ~ +5 dB

MIC Gain:
-5 dB ~ +5 dB

Sound Type setting (Type Setup)

Depending on your calling environment, choose one of the settings below which gives the best sound quality.

Setting contents:

TYPE1 (Initial setting) / TYPE2 / TYPE3 / TYPE4 / TYPE5

TYPE1:
Standard Mode (recommended)

TYPE2:
Enhances the noise reduction

TYPE3:
Enhances the echo-cancel

TYPE4:
Enhances both noise reduction and echo-cancel

TYPE5:
Weakens both noise reduction and echo-cancel

Note

- The functions below are designed to improve the sound quality of the outgoing call.
Noise reduction: This function can reduce the road noise, but excessive enhancement may affect the sound quality of the call.
Echo-cancel: This function can reduce the echo, but excessive enhancement may affect the sound quality of the call.

Setting the caller information display/ text message indicator ON/OFF

You can choose whether to use these functions according to the following setting.

■ **Setting item:** Caller ID

Setting contents:

OFF / ON (Initial setting)

If you want to keep the ID information of the caller from others, set this item to OFF. Depending on the stored ID information, while you are dialing a number or a call is dialing in, only telephone number will be displayed or telephone name will be displayed as "NO Name"; During a call, "NO Name" will be displayed.

Setting the Phone Book Update

You can update the phone book automatically or manually.

■ **Setting item:** PB Update

■ **Further Setting contents:** Auto / Manual

Setting the Phone Book Auto Update ON/OFF (Auto)

When you select ON in this step, whenever the vehicle's ignition is turn ON or after the phone is connected with this unit, the phone book will be updated automatically.

Setting contents:

OFF / ON (Initial setting)

Note

- "Updating" will be displayed during the phone book update.

Setting the Phone Book Manual Update ON/OFF (Manual)

When you select YES in this step, the phone book will be updated immediately regardless if the Auto update function is on or off.

Setting contents:

NO (Initial setting) / YES

Note

- "Updating" will be displayed during the phone book update.

Changing the Phone book List Order

The phone book is listed alphabetically by the first letter of First or Last Name.

Listing by First Name is the default but Last Name can be selected.

■ **Setting item:** PB Order

Setting contents:

First Name (Initial setting) / Last Name

Note

- "Waiting" will be displayed while the Phone book order is switching. You can cancel the "Waiting" screen to perform other operations by pressing **↵** when the ordering is still in progress. The phone book is not accessible during this time. In addition, the ordering may affect the playback of Bluetooth Audio.

Setting the Received Calls automatically (Auto Answer)



When a call is received, you can set whether to receive it automatically or not.

Setting item: Auto Answer

Setting contents:

OFF (Initial setting) / ON

OFF:

When a call is received, it is not answered automatically. Press  or /ENTER to receive the call.

ON:

When a call is received, it is answered automatically after about 5 seconds.

Note

- If the received call setting on the Smartphone is on, the call will be answered automatically even though this setting is set to OFF.

Displaying the phone service provider name

The service provider name of the connected BLUETOOTH compatible device will be displayed. If a BLUETOOTH compatible device is not connected, "ID Unsent" will be displayed.

Setting item: Service Name

Note

- Depending on the character type some phone service provider name cannot be displayed. "ID Unsent" will be displayed.

Selecting the output speaker

Choose the speaker in your vehicle from which you want to hear the call.

Setting item: Speaker Select

Setting contents:

ALL (Initial setting) / F-L / F-R / F-LR

ALL:

The sound be output from all of speakers in car.

F-L:

The sound only be output from the front left speaker.

F-R:

The sound only be output from the front right speaker.

F-LR:

The sound be output from the front left and front right speaker.

Displaying the firmware version

The current firmware version will be displayed.

Setting item: FW Version

Updating the firmware

Future BLUETOOTH firmware updates may become available for phone interoperability.

For detailed information and operation to update your BLUETOOTH firmware, please visit your local Alpine website or choose your country from Alpine Europe top page (<http://www.alpine-europe.com>).

Setting item: FW Update

Setting contents:

NO (Initial setting) / YES

Hands-Free Phone Control

About the Hands-Free Phone

Hands-free calls are possible when using a HSP (Head Set Profile) and HFP (Hands-Free Profile) compatible Smartphone with this unit.

Notes

- Avoid performing a hands-free call in heavy traffic or on narrow or winding streets.
- Close the windows while calling to reduce background noise.
- If both calling parties are using hands-free devices, or the call is made in a noisy location, difficulty hearing the other person's voice is normal.
- Depending on telephone line conditions or certain mobile devices used, voices may sound unnatural.
- When using a microphone, speak as directly as you can into the microphone to pick up the best sound quality.
- Certain Smartphone features are dependent on the capabilities and settings of your service provider's network. Additionally, certain features may not be activated by your service provider, and/or the provider's network settings may limit the feature's functionality. Always contact your service provider about feature availability and functionality.

All features, functionality, and other product specifications, as well as the information contained in the Owner's Manual are based upon the latest available information and are believed to be accurate at the time of printing.

Alpine reserves the right to change or modify any information or specifications without notice or obligation.

Answering a Call

Incoming calls are announced by the received call ring tone and a displayed message (Phone).

Press  or press /ENTER.

The call starts.

Notes

- When "Auto Answer" is set to ON, you can receive a call automatically. Refer to "Setting the Received Calls automatically (Auto Answer)" on page 34.
- While calling, the source sound on the unit is muted. After calling, playback will resume.

Hanging up the Telephone

Press .

The call finishes.

Note

- You can also hang up the call by pressing .

Voice Control Operation

When a Smartphone equipped with voice recognition function is paired with this unit. The Smartphone can be controlled by Voice Control via this unit.

Press and hold VOICE CTRL. for at least 2 seconds to activate the Voice Recognition mode.

After the Voice Recognition mode is activated and "Speak" is displayed, you can make a phone call, play a song, etc., via this unit by inputting voice control commands.

* Please refer to your Smartphone manual for other voice control commands.

Notes

- You can perform this operation only when a Voice recognition compatible Smartphone is connected. If the Smartphone is not compatible with the Voice recognition, "No Support" is displayed for 2 seconds.
- The Voice recognition function performance depends on the recognition range of the Smartphone and mounting location of the microphone. Please pay attention when the microphone is mounted.
- Voice recognition operation depends on the function of the Smartphone. For details, refer to the Owner's Manual of the Smartphone.
- If a called person that you say is not found, "No Call" is displayed for 2 seconds.
- Please obey all local traffic laws while using this function.

Calling

Call History is recorded for the last dialled/received/missed calls (20 records for each). There are various ways of making calls based on the "Calling". The following steps 1 to 5 are common to the various ways of making these calls. For details, refer to each individual category for making calls.

1 Press .

The outgoing method list is displayed.

2 Turn the Rotary encoder to select the outgoing mode.

Setting contents:

Dialled / Received / Missed / Phone Book

Dialled:

Dialled history

Received:

Received history

Missed:

Missed incoming history

Phone Book:

Smartphone phone book

3 Press /ENTER.

The outgoing mode is activated, and each mode list is displayed.

Note

- It may take some time for the list to be displayed, and also directly after connection, the list may not be brought up to date.



4 Turn the Rotary encoder to select a name or a telephone number from the list.

Note

- You can use Phone book alphabet search function to search a name or number from Phone Book. For details, refer to "Phone book Alphabet Search Function" on page 35.

5 Press /ENTER.

The selected telephone number will be called.

If one name has several numbers registered in the telephone book, press  /ENTER after selecting the name*, then turn the Rotary encoder to choose the desired number and press  /ENTER, the telephone will be called.

- * If the name cannot be recognized, "NO Name" will be displayed.

Notes

- Press  to return to the previous mode.
- If no operation is performed for 60 seconds, the unit will return to normal mode automatically.

Redialing a Number in Outgoing History

Previously dialled telephone numbers (maximum number of call record is 20) are stored in dialled calls history. You can redial a number by searching from dialled calls history.

Setting item: Dialled

Dialing a Number in Incoming History

Telephone numbers (maximum number of call record is 20) from received calls are stored in the Received List. You can redial these numbers by searching here.

Setting item: Received

Dialing a Number in Incoming Missed Call History

Telephone numbers (maximum number of call record is 20) for received calls that are missed, are stored in the Missed List. You can redial these numbers by searching here.

Setting item: Missed

Dialing a Number in the Phone Book

Up to 1,000 names (at most 3 telephone numbers for each name) are downloadable from a Smartphone. Dial a call by selecting a person from the phone book list.

Setting item: Phone Book

Notes

- The order of the list display depends on the setting of "PB Order" (refer to "Changing the Phone book List Order" on page 33).
- If the call history or phone book of the Smartphone is added or deleted while it is connected to the unit, the list displayed on the unit may not be brought up to date. If it is not updated, you cannot correctly place a call.
- You can display the information of a number stored in phone book by pressing **VIEW**. Each press changes the display as Name → Telephone NO./Telephone label → Name. If the information cannot be obtained, "NO Name", or "NO Number" will display.
- * The telephone label of a number depends on the number information stored in Phone book of the Smartphone, which includes 4-type icons -(Mobile), (Home), (Work), and (Other).

Phone book Alphabet Search Function

You can select the first three letters to search for a desired name in phone book list by using the Phone book alphabet search function.

For example:

Searching a name "Michael James"

The following example explains how the search is performed.

Depending on the setting in PB Order (refer to "Changing the Phone book List Order" on page 33), the phone book is listed in first name or last name order. Please search for the first name or last name according to the setting.

1 Press **ABC SEARCH** while in the phone book list, the phone book alphabet search mode is activated.

The letter selection screen is displayed.

2 Turn the Rotary encoder to select the first letter (e.g. M), and then press **▶▶**.

3 Turn the Rotary encoder to select the second letter (e.g. I), and then press **▶▶**.

4 Turn the Rotary encoder to select the third letter (e.g. C), and then press **Q** /ENTER.

The names stored in phone book which begin with "MIC" are searched.

5 Turn the Rotary encoder to select the desired name (e.g. Michael James), and then press **Q** /ENTER to make the call.

Notes

- The initial setting of the Alphabet Search Function is only applicable to English alphabet characters, but when "Russian" is set, Phone book alphabet search function is also applicable to Russian letters. Refer to "Setting the Menu Language" on page 28.
- If the selected name has several numbers registered in phone book, you need to turn the **Rotary encoder** to select the desired number, and then press **Q** /ENTER.
- Press **◀** in step 3 or 4 to delete the current entry and return to the previous step.
- You can search for a name by its first letter, first two letters or first three letters. Press **Q** /ENTER after entering the desired number of letters. A list displays the names beginning with the entered letter(s).

Call waiting function

If a second call is received during a current call, you can have the first caller wait momentarily while you take the second call. When you are finished with one call, you can switch to the other one.

If a second call is received during the current call (call1), the information of second caller (call2) is displayed instead of the current caller's name. Press **▶ 2, the call waiting mode is activated.**

In this case, call1 is on hold, while you take call2.

Notes

- In the call waiting mode, press **1** ◀ or ▶ **2** to switch between the current call and the person on hold.
- In the call waiting mode, press and hold **1** ◀ or ▶ **2** for at least 2 seconds to hang up call1 or call2, and the other call will be answered automatically. (The action depends on the paired device.)
- In the call waiting mode, you can press **VIEW** to change the display between waiting number (1or 2) and caller name.

Preset a number in the Phone Menu (Shortcut dial)

Assign numbers that you dial frequently to presets for quick recall. You can assign up to six frequently called phone numbers to number presets.

Select a number you want to preset from the Phone Menu list (Phone Book, Dialed Call, etc.). Press and hold any one of the preset buttons (1 through 6) as the one that you wish to store the number for at least 2 seconds.

The phone number you selected is stored in presets.

Notes

- If the name has several numbers registered in the phone book, press **Q** /ENTER after selecting the name. Turn the **Rotary encoder** to choose the desired number. Press and hold any one of the **preset buttons (1 through 6)** for at least 2 seconds. The selected number is stored as a preset number.
- A total of 18 phone numbers can be stored in the preset memory (6 numbers for each Smartphone in the paired device list). If a Smartphone is deleted from the paired device list, the stored preset numbers of this Smartphone are deleted, even when it is paired again.
- If you store a phone number in a preset with a previously stored number, the current number will be cleared and replaced by the new one.

Dialing the preset number

1 Press any one of the preset buttons (1 through 6) that has had a number stored in the phone mode.

The information (name/number) stored in the preset station is displayed.

2 Press **Q** /ENTER or **↵**.

The stored preset number is dialed directly.

Adjusting the volume when receiving a Call

While calling, you can adjust the volume.

Turn the Rotary encoder to adjust the volume.

Note

- You may need to increase volume from your regular audio listening source level. However, increasing the volume excessively may result in feedback. Feedback is directly related to the volume. Turning down the volume as low as acceptable, will reduce it. Positioning the microphone in a direction away from the main car speakers (e.g. clipped on sun visor) may also reduce feedback at high volume.

Muting the microphone input quickly (Voice Mute)

While calling, activating the Voice Mute function will instantly mute the microphone input. Your voice will not be heard by the caller.

While calling, press **▶/|| to mute the microphone input.**

Press **▶/||** again will bring the microphone input back to its previous volume level.

Call Switching Operation

While making a call, this function allows you to initiate the transfer of the audio between the Smartphone and the speakers in the car.

While calling, press **BAND or press and hold **▶/||** for at least 2 seconds to switch the call sound between the unit and Smartphone.**

Note

- Depending on the Smartphone, this operation may not be performed.

Bluetooth Audio Operation

Audio information of a BLUETOOTH compatible Smartphone, a portable player, etc., is controllable/playable wirelessly* from this unit.

- * To play back audio, a Smartphone or a portable player conforming to A2DP (Advanced Audio Distribution Profile) and AVRCP (Audio/Video Remote Control Profile) is required.
Not all functions work with all devices.

Notes

- Set "Bluetooth IN" to ON when you want to use Bluetooth Audio function. Refer to "Setting the BLUETOOTH Connection (Bluetooth IN)" on page 32.
- During a call, sound on the BLUETOOTH audio source is muted.
- If you operate the Hands-free phone (e.g. searching in the phonebook) while using the Bluetooth Audio function, BLUETOOTH Audio playback may be affected.

Recalling the Bluetooth Audio Mode

Press **Q** /SOURCE to select the BLUETOOTH Audio mode.

Selecting the desired Song

- 1 Press **I◀◀**.
Returns the beginning of the song being played back.
- 2 Press **▶▶I**.
Forwards the next song.
Pressing and holding **I◀◀** or **▶▶I** will fast backward/fast forward track continuously.

Note

- The action depends on the paired device.

Selecting the desired Group (Folder)

Press **1** ◀ or ▶ **2** to select the desired Group (Folder)

Pressing and holding **1** ◀ or ▶ **2** will change folders continuously.

Note

- This function may not be available depending on the paired device.

Pausing

Press **▶/II**.

A playback stops. Pressing again will resume a playback.

Searching for a desired song

Artist name, album name, etc., may be searched and displayed during playback or pause.

- 1 Press **Q** /ENTER to activate the search mode.
- 2 Turn the **Rotary encoder** to select the desired Group (Folder), and then press **Q** /ENTER.
- 3 Turn the **Rotary encoder** to select the desired album, folder, etc., within the selected Group (Folder), and then press **Q** /ENTER.
- 4 Repeat step 3 if necessary until the desired song is found.

Notes

- Search mode may differ depending on the connected device.
- The pause mode may be cancelled after the search.
- This function may not be available depending on the paired device.

USB Memory (optional)

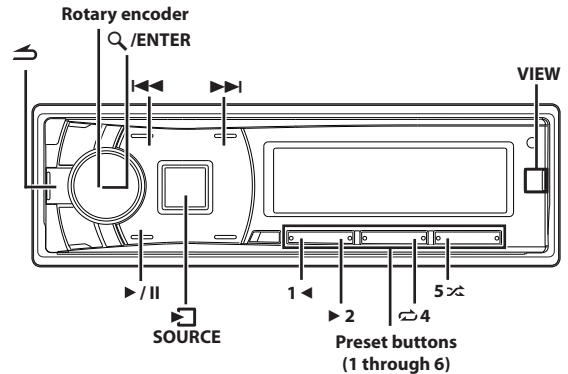

Note

- You can connect Nokia (Symbian™) phone via USB port to play back the music stored on your phone.

Connecting the USB Memory (optional)

If a USB Memory device is connected to the unit, MP3/WMA/AAC files can be played back.

Playback

- 1 Press **Q** /SOURCE to select the USB mode.
- 2 Press **I◀◀** or **▶▶I** to select the desired track (file).
Pressing and holding **I◀◀** or **▶▶I** will fast backward/fast forward track continuously.
- 3 To pause playback, press **▶/II**.
Pressing **▶/II** again will resume playback.

Notes

- Any file protected by DRM (Digital Rights Management) copy protection, cannot be played back on this unit.
- The playback time may not be correctly displayed when a VBR (Variable Bit Rate) recorded file is played back.
- If there is tag information, artist name/album name/song name is displayed.
- If an MP3/WMA/AAC file contains ID3 tag/WMA tag information, the ID3 tag/WMA tag information is displayed (e.g., song name, artist name, and album name). All other tag data is ignored.
- If text information is not compatible with this unit, the display is blank.
- Before disconnecting USB Memory, be sure to change to another source or set to pause.
- Press **VIEW** to switch the display. For details, refer to "Displaying the Text" on page 23.

Repeat Play

1 Press 4.

The song is played back repeatedly.

RPT*¹ → RPT ^{*2} → (off) → RPT

*1 Only a file is repeatedly played back.

*2 Only files in a folder are repeatedly played back.

2 To cancel repeat play, select (off) with the above procedure.



Note

- During repeat play, setting M.I.X. to ON will cancel the repeat play.

M.I.X. (Random Play)

1 Press 5 .

The songs are played back in random sequence.

MIX ^{*1} → MIX ALL ^{*2} → (off) → MIX 

*1 All songs in the current folder are played back in random sequence. Any one song does not play back again until all songs have been played back.

*2 All songs in the USB Memory are played back in random sequence. Any one song does not play back again until all songs have been played back.

2 To cancel M.I.X. play, select (off) with the above procedure.

Notes

- When a song is played back during Random (M.I.X.) play in the USB mode, the song can be played back again randomly even if not all songs in the USB memory have been played back.
- During M.I.X. play, setting repeat play to ON will cancel the M.I.X. play.
- During repeat play, etc., the track number display for M.I.X. play may be incorrect.

Searching for a desired Song

USB Memory can contain hundreds of songs. By organizing songs by folder, you can quickly find a desired folder/file. This operation is similar to search a folder/file from PC.

1 Press /ENTER to activate the search mode.

2 Turn the Rotary encoder to select a desired folder/file.

3 Press /ENTER to play the selected file or enter the selected folder.

Press and hold  /ENTER for at least 2 seconds to play back all songs in the selected folder.

4 If a folder is opened in Step 3, Repeat Steps 2 to 3 until the desired folder/file is found.

Notes

- If no operation is performed for 60 seconds, the search mode is cancelled.
- The root folder of USB Memory is displayed as “\ROOT”.
- In the search mode, pressing  will return to the previous mode.
- When search is made during M.I.X. play, the M.I.X. play mode will be cancelled.

- If any one of the **preset buttons (1 through 6)** is pressed in the search mode, a search can be made quickly by skipping to the specified location. For details, refer to “Direct Search Function” on page 40.
- In the search mode, a search can be made quickly by USB Skip function to find the desired folder/file. For details, refer to “Setting the USB Skip function” on page 30.
- The total folders/files should be less than 1,000 (512 files for root folder) in each search hierarchy.

Select Folder

Folder can be easily changed. For example, if you listen to a song from a selected folder, the folder can be changed.

Press 1  or  2 to select the desired Folder.

Note

- This function is inactive during MIX ALL playback.

Search Position Memory

During playback, you can quickly return to the last-selected hierarchy level in the search mode.

Press .

The hierarchy you selected last in the search mode is displayed.

iPod/iPhone (optional)

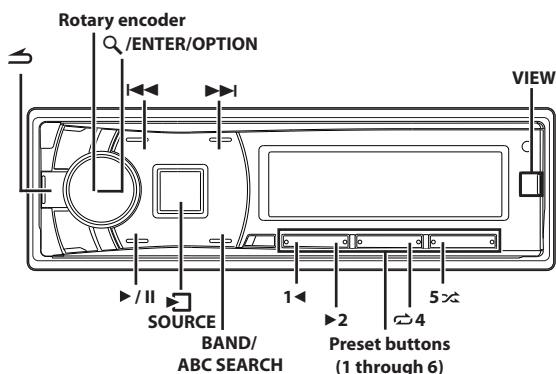

Connecting an iPod/iPhone

An iPod/iPhone can be connected to this unit by using the Interface cable for iPod (included with iPod/iPhone). When this unit is connected by using the cable, the controls on the iPod are not functional.

Notes

- Internet and telephone functions of the iPod touch or iPhone, ect., can also be used while connected to this unit. However, using these functions will stop or pause the playing songs. Stop using any application or the phone functions before going back to music playback on your device .
- If you connect an iPhone to this unit, it can be used as an iPod. If you use iPhone as a hands-free phone, use the unit in which the BLUETOOTH function is built.

About iPod/iPhone models usable with this unit

- Confirmed devices regarding Made for iPod. Correct function of earlier versions cannot be guaranteed.
 - iPod touch (4th generation): Ver.5.1.1
 - iPod nano (6th generation): Ver.1.2
 - iPod touch (3rd generation): Ver.5.1.1
 - iPod nano (5th generation): Ver.1.0.2
 - iPod classic (160 GB) (Late 2009): Ver.2.0.4
 - iPod touch (2nd generation): Ver.4.2.1
 - iPod nano (4th generation): Ver.1.0.4
 - iPod classic (120 GB): Ver.2.0.1
 - iPod touch (1st generation): Ver.3.1.3
 - iPod nano (3rd generation): Ver.1.1.3
 - iPod classic (80 GB, 160 GB): Ver.1.1.1.2
- Confirmed devices regarding Made for iPhone. Correct function of earlier versions cannot be guaranteed.
 - iPhone 4S: Ver.5.1.1
 - iPhone 4: Ver.5.1.1
 - iPhone 3GS: Ver.5.1.1
 - iPhone 3G: Ver.4.2.1
 - iPhone: Ver.3.1.3
- For clarity in identifying your model of iPod, please see Apple's own document "Identifying iPod models" at <http://support.apple.com/kb/HT1353>
- This unit does not support video playback from iPod/iPhone, even using a video-compatible cable.

Setting the iPod Control

When an iPod/iPhone is connected, operate it from its own controls or from the head unit.

- 1 Press and hold **Q /ENTER/OPTION** for at least 2 seconds in the iPod mode.

The Option menu for iPod mode is activated.

- 2 Turn the **Rotary encoder** to select "APP Direct", and then press **Q /ENTER**.

The iPod control mode will switch between iPod Mode and HU Mode.

HU Mode (HEAD UNIT):

Operate the iPod/iPhone via this unit.

iPod Mode:

Operate the iPod/iPhone using its own controls. When iPod is selected, some functions will not be operable via the head unit.

Notes

- During HU Mode, you can switch to iPod Mode directly by pressing **BAND**.
- Once the control mode is changed, this will set pause status, press **▶/||** to continue.
- Depending upon the iPod used, iPod control may not be selectable. Or, if iPod is selected, operation must still be from the head unit.

Playback

- 1 Press **◀/SOURCE** to switch to the iPod mode.

- 2 Press **◀◀** or **▶▶** to select the desired song.

Pressing and holding **◀◀** or **▶▶** will fast backward/fast forward the current song.

- 3 To pause playback, press **▶/||**.

Pressing **▶/||** again will resume playback.

Notes

- A song playing on the iPod/iPhone while it is connected to this unit will continue to play from where it was paused after disconnection.
- If you listen to an episode from a selected podcast or audiobook, the episode can be changed by pressing **1 ◀** or **▶ 2**.
- An episode may have several chapters. The chapter can be changed by pressing **◀◀** or **▶▶**.

Searching for a desired Song

An iPod/iPhone can contain hundreds of songs. This unit utilizes various methods to make searches for desired content as simple as possible. Each music category has its own individual hierarchy as shown below. Choose a music category from the list below to narrow searches quickly.

Hierarchy 1	Hierarchy 2	Hierarchy 3	Hierarchy 4
Playlist	Song	—	—
Artist*	Album*	Song	—
Album*	Song	—	—
Song	—	—	—
Podcast	Episode	—	—
Genre*	Artist*	Album*	Song
Composer*	Album*	Song	—
Audiobook	—	—	—
Genius Mix list	—	—	—

For example:

Searching by Artist name.

The following example explains how an Artist search is performed.

Another search mode can be used for the same operation, although the hierarchy differs.

- Press **Q** / **ENTER** to activate the search selection mode.
- Turn the **Rotary encoder** to select the **Artist** search mode, and then press **Q** / **ENTER**.
Shuffle All^{*1} ↔ Playlist ↔ Artist ↔ Album ↔ Song ↔ Podcast ↔ Genre ↔ Composer ↔ Audiobook ↔ Genius Mix^{*2/*3} ↔ Shuffle All^{*1}

*1 Refer to "Random Play Shuffle (M.I.X.)" on page 41.
*2 Depending on the connected iPod/iPhone, Genius Mix function may not be supported.
*3 When an iPod/iPhone with Genius Mix List created by iTunes is connected to this unit, Genius Mix search mode can be used to search a Genius Mix List.
- Turn the **Rotary encoder** to select the desired **Artist**, and then press **Q** / **ENTER**.
- Turn the **Rotary encoder** to select the desired **Album**, and then press **Q** / **ENTER**.
- Turn the **Rotary encoder** to select the desired **Song**, and then press **Q** / **ENTER**.
The selected song is played back.

Notes

- After pressing and holding **Q** / **ENTER** for at least 2 seconds while in each hierarchy (except Song, Audiobook and Genius Mix list hierarchy), all songs of the selected hierarchy are played back.
- After selecting [All] in the search mode, press and hold **Q** / **ENTER** for at least 2 seconds to play back all songs in the iPod/iPhone or selected search mode.
- If no operation is performed for 60 seconds, the search mode is cancelled.
- In the search mode, pressing **⏮** will return to the previous mode.
- When search is made during M.I.X. play, the M.I.X. play mode will be cancelled.
- "No Song" will be displayed if there are no songs in the selected playlist in the Playlist search mode.
- "No Podcast" will be displayed if there is no podcast data in the iPod/iPhone in the Podcast search mode.

- "No Audiobook" will be displayed if there is no audiobook data in the iPod/iPhone in the Audiobook search mode.
- "No Genius" will be displayed if there is no genius mix list data in the Genius Mix search mode.
- If "iPod name" stored in the iPod/iPhone is selected in the desired Playlist search mode, and **Q** / **ENTER** is pressed, you can search for all songs in the iPod/iPhone. Also, if you press and hold **Q** / **ENTER** for at least 2 seconds, all songs in the iPod/iPhone are played back.
- Depending on the iPod/iPhone, podcast search is not supported.
- During search mode, a search can be made quickly by Alphabet search function to find the desired artist or song, etc. For details, refer to "Alphabet search function" on page 41.
- If any one of the **preset buttons (1 through 6)** is pressed in the search mode, a search can be made quickly by skipping to the specified location. For details, refer to "Direct Search Function" on page 40.

Direct Search Function

Direct search can be used to jump a fixed percentage of titles within the current search category (album, song, etc.).

In the search mode, press any one of the **preset buttons (1 through 6)** to quickly skip over a designated percent of your song content.

Song search example:

If there are 100 songs in your iPod/iPhone, they are divided into 6 groups using percentages (shown below). These groups are assigned to preset buttons 1 through 6.

Example 1:

Suppose the song you are searching for is located at around the middle (50%) of your library: press button 4 to jump to the 50th song and turn the **Rotary encoder** to find the desired song.

Example 2:

Suppose the song you are searching for is located near the end (83%) of your library: press button 6 to jump to the 83rd song and turn the **Rotary encoder** to find the desired song.

	All 100 songs (100%)					
	0%	17%	33%	50%	67%	83%
Preset buttons	1	2	3	4	5	6
Songs	1st song	17th song	33rd song	50th song	67th song	83rd song

Notes

- This function is also applicable to CD/MP3/WMA/AAC search.
- This function is inactive during Alphabet Search mode.
- This function is unavailable when Genius Mix List is selected.

Change Playlist/Artist/Album/Genre/Composer/Episode

Playlist/Artist/Album/Genre/Composer/Episode can be easily changed. For example, if you listen to a song from a selected album, the previous or next album can be selected.

Press **1** ◀ or ▶ **2** to change to the previous or next Playlist/Artist/Album/Genre/Composer/Episode.

Notes

- If the song search mode was used to select a song, this function is inactive.
- If an album is selected during an artist search, other albums by that artist are searchable.
- This function is inactive during shuffle (M.I.X.) playback.

Alphabet search function

Use the alphabet search function to search for an album, song, etc., by its first letter. Select the first letter of the desired title (album, song, etc.), and the titles beginning with this letter are listed.

1 In the search mode, press **ABC SEARCH**.

The letter selection list is displayed.

2 Turn the **Rotary encoder** to select a desired letter (e.g. M), and then press **Q / ENTER**.

The titles beginning with "M" are listed.

3 Turn the **Rotary encoder** to select the desired title.

Notes

- While in Alphabet search mode, pressing **↶** will return to the previous mode.
- If the Playlist search mode is used to search for a song, the Alphabet search function is inactive in the song search hierarchy.
- This function is unavailable when Genius Mix List is selected.

Search Position Memory

During iPod/iPhone playback, you can quickly return to the last-selected hierarchy level in the search mode.

Press **↶**.

The hierarchy you selected last in the search mode is displayed.

Random Play Shuffle (M.I.X.)

The Shuffle function of the iPod/iPhone is displayed as M.I.X. on this unit.

Shuffle Albums:

The songs on each album are played back in proper order. Upon completion of all the songs on the album, the next album is selected randomly. This continues until all albums have been played.

Shuffle Songs:

Song shuffle randomly plays back songs within a selected category (playlist, album, etc.). The songs within the category are played just once until all songs have been played.

1 Press **5** **↶**.

The songs are played back in random sequence.

MIX **☑***1 → MIX*2 → (off) → MIX **☑**

*1 Shuffle Albums.

*2 Shuffle Songs.

2 To cancel M.I.X. play, select (off) with the above procedure.

Note

- If a song is selected in the album search mode before selecting M.I.X. play, the songs will not play back randomly even when Shuffle Albums is selected.

Shuffle All:

Shuffle All plays all songs in the iPod/iPhone randomly. Any one song does not play back again until all songs have been played back.

1 Press **Q / ENTER** to activate the search selection mode.

2 Turn the **Rotary encoder** to select Shuffle All, and then press **Q / ENTER**.

To cancel M.I.X. play, press **5** **↶** to select OFF.

Note

- If Shuffle All is selected, the selected songs being played back in the search mode are cancelled.

Repeat Play

Only Repeat One is available for the iPod/iPhone.

Repeat One:

A single song is repeatedly played back.

1 Press **↶** **4**.

The song is played back repeatedly.

RPT* → (off) → RPT

* Repeat One.

2 To cancel repeat play, select (off) with the above procedure.

Note

- Depending on the connected iPod, track up/down may be not available during Repeat play.

vTuner internet radio (iPhone) (Optional)

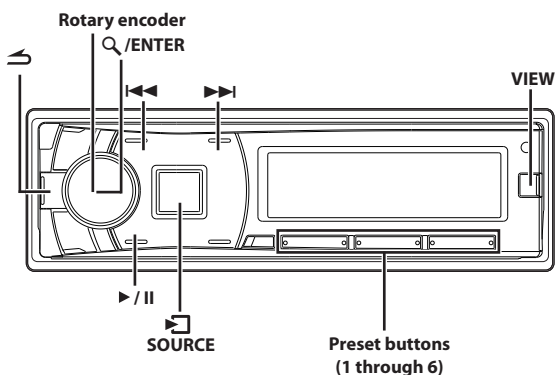

vTuner is your guide to Internet streamed media. The vTuner platform connects your Internet enabled iPhone to the wide world of streamed music, talk, etc.

Notes

- Some of the vTuner application functionality for iPhone or iPod touch is not available when using the CDE-178BT/iDE-178BT/CDE-175R.
- vTuner is also usable from an iPod touch with Wi-Fi connection.
- Be aware that the vTuner function will consume your communication fee.
- The vTuner source can be displayed only when Alpine APP is set to USB. For details, refer to "Setting the communication mode with a Smartphone (Alpine APP)" on page 30.

Listening to vTuner

- 1 Launch the vTuner Application on the iPhone.
- 2 Press **SOURCE** to switch to the vTuner mode.
- 3 To pause playback, press **▶/II**.

Pressing **▶/II** again will resume playback.

If the broadcasting programme is not transmitted by streaming media, when playback is continued, it will begin at the position it was paused.

Note

- vTuner audio could drop out in areas with poor phone coverage.

Storing the desired station to Favourite List

You can store a station to the Favourite List by following steps.

Press **▶▶** when the station you want to store is broadcasting.

The **(★)** indicator will light up after the station is added to Favourite List successfully.

Fail will be displayed if the station fails to be added to Favourite List or while the Favourite List is full you want to add station to it.

Note

- The number of stations that can be added to the Favourite List depends on the vTuner application.

Jumping to Favourite station

During vTuner source, press any one of preset buttons (1 through 6).

The relevant station (1 through 6) stored in Favourite List begins to broadcast and **(★)** indicator lights up.

Notes

- Preset 1 to 6 are stations stored in the Favourite List in order of 1~6.
- You can also choose a stored station from Favourites search in search mode.

Deleting stored station from Favourite List

- 1 Tune to a stored (favourite) station.
- 2 Press **◀◀**.
The **(★)** indicator will go off after the station is deleted from Favourite List.
Fail will be displayed if the station fails to be deleted from Favourite List.

Searching for a Desired Station

You can display your station list and select stations directly from the CDE-178BT/iDE-178BT/CDE-175R.

Search a station from Favourite list:

- 1 Press **Q/ENTER** to activate the Search mode.
- 2 Turn the **Rotary encoder** to select "Favourites", and then press **Q/ENTER**.
The "Favourites" search mode is activated and the stored station names are listed.
- 3 Turn the **Rotary encoder** to select the desired station, and then press **Q/ENTER**.
vTuner will play that station and **(★)** indicator will light up.

Search by other modes:

vTuner provides you many ways to search a station, such as by Genre, Location, etc. And some search categories may include many search hierarchies. For details, please visit <http://www.vtuner.com>.

- 1 Press **Q/ENTER** to activate the search mode.
- 2 Turn the **Rotary encoder** to select the desired search category, and then press **Q/ENTER**.
- 3 Turn the **Rotary encoder** to select the desired subcategory/station within the selected category, and then press **Q/ENTER**.
- 4 Repeat step 3 until the desired station is searched.

Notes

- While in the search mode, if no operation is performed for 60 seconds, the search mode is cancelled.
- In the search mode, pressing **↶** will return to the previous search hierarchy.
- Depending on the vTuner application, search category, search hierarchy, etc., may differ.

- During search mode, press **VIEW** may change the display.
- In some cases, certain search mode may not work, or some stations cannot play normally.
- The provided stations are subject to change, please visit the home page of vTuner for the latest information.

Information

In Case of Difficulty

If you encounter a problem, turn the power off, then on again. If the unit is still not functioning normally, review the items in the following checklist. This guide will help you isolate the problem if the unit is at fault. Otherwise, make sure the rest of your system is properly connected or consult your authorized Alpine dealer.

Basic

No function or display.

- Vehicle's ignition is off.
 - If connected following instructions, the unit will not operate with the vehicle's ignition off.
- Improper power lead (Red) and battery lead (Yellow) connections.
 - Check power lead and battery lead connections.
- Blown fuse.
 - Check the fuse of the unit; replace with the proper value if necessary.
- Internal micro-computer malfunctioned due to interference noise etc.
 - Press the RESET switch with a ballpoint pen or other pointed article.

Radio

Unable to receive stations.

- No antenna or open connection in cable.
 - Make sure the antenna is properly connected; replace the antenna or cable if necessary.

Unable to tune stations in the seek mode.

- You are in a weak signal area.
 - Make sure the tuner is in the DX mode.
- If the area you are in is a primary signal area, the antenna may not be grounded and connected properly.
 - Check your antenna connections; make sure the antenna is properly grounded at its mounting location.
- The antenna may not be the proper length.
 - Make sure the antenna is fully extended; if broken, replace the antenna with a new one.

Broadcast is noisy.

- The antenna is not the proper length.
 - Extend the antenna fully; replace it if it is broken.
- The antenna is poorly grounded.
 - Make sure the antenna is grounded properly at its mounting location.

CD

CD Player not functioning.

- Out of operating temperature range +50°C (+120°F) for CD.
 - Allow the vehicle's interior (or trunk) temperature to cool.

CD playback sound is wavering.

- Moisture condensation in the CD Module.
 - Allow enough time for the condensation to evaporate (about 1 hour).

CD insertion not possible.

- A CD is already in the CD player.
 - Eject the CD and remove it.

- The CD is being improperly inserted.
 - Make sure the CD is being inserted following instructions in the CD Player Operation section.

Unable to fast forward or backward the CD.

- The CD has been damaged.
 - Eject the CD and discard it; using a damaged CD in your unit can cause damage to the mechanism.

CD playback sound skips due to vibration.

- Improper mounting of the unit.
 - Securely re-mount the unit.
- The disc is very dirty.
 - Clean the disc.
- The disc has scratches.
 - Change the disc.
- The pick-up lens is dirty.
 - Do not use a commercially available lens cleaner disc. Consult your nearest Alpine dealer.

CD playback sound skips without vibration.

- The disc is dirty or scratched.
 - Clean the disc; damaged disc should be replaced.

Error displays (built-in CD player only).

- Mechanical error.
 - Press **▲**. After the error indication disappears, insert the disc again. If the above-mentioned solution does not solve the problem, consult your nearest Alpine dealer.

CD-R/CD-RW playback not possible.

- Close session (finalization) has not been performed.
 - Perform finalization and attempt playback again.

MP3/WMA/AAC

MP3, WMA or AAC is not played back.

- Writing error occurred. The MP3/WMA/AAC format is not compatible.
 - Make sure the MP3/WMA/AAC has been written in a supported format. Refer to “About MP3/WMA/AAC” on page 16, then rewrite in the format supported by this device.

Audio

The sound is not output from the speakers.

- There is no signal output from the internal amplifier.
 - Power IC is switched to “ON” (refer to “Connecting to an External Amplifier” on page 19).

iPod

iPod does not play and no sound is output.

- The iPod has not been recognized.
 - Reset this unit and the iPod. Refer to “Initial System Start-Up” on page 10. To reset the iPod, refer to the Owner’s Manual of the iPod.

Indication for CD Player

No Disc

- No CD is inserted.
 - Insert a CD.
- Although a disc is inserted, “No Disc” is displayed and the unit does not start to play or eject the disc.
 - Remove the disc by following these steps:
 - Press the **▲** button again for at least 2 seconds.
 - If the disc still does not eject, consult your Alpine dealer.

Error

- Mechanism error.
 - 1 Press the **▲** button and eject the CD.
 - If not ejecting, consult your Alpine dealer.
 - 2 When the error indication remains after ejecting, press the **▲** button again.
 - If the error indication still does not turn off after pressing the **▲** button for a few times, consult your Alpine dealer.
- When “Error” is displayed:
 - If the disc cannot be ejected by pressing **▲**, press the RESET switch (refer to “Initial System Start-Up” on page 10) and press **▲** again.
 - If the disc still cannot be ejected, consult your Alpine dealer.

Protect

- A copy-protected WMA file was played back.
 - You can only play back non-copy-protected files.

Unsupported

- A sampling rate/bit rate not supported by the unit is used.
 - Use a sampling rate/bit rate that is supported by the unit.

Indication for USB Memory

Error-01

- Database error or decoder error.
 - You can solve the problem by switching the source.

Error-02

- Communication error or boot error, etc.
 - You can solve the problem by reconnecting the USB Memory, changing source or format the USB memory.

Current Error

- Abnormal current is run to the USB connector device.
 - You can solve the problem by switching the source.

USB Device Error

- A USB device that is not supported by the unit is connected.
 - Connect a USB device that is supported by the unit.

No USB Unit

- A USB Memory is not connected.
 - Make sure the USB Memory device is correctly connected and the cable is not excessively bent.

No Song

- No song (file) is stored in the USB Memory.
 - Connect the USB Memory device after storing songs (files).

Unsupported

- A sampling rate/bit rate not supported by the unit is used.
 - Use a sampling rate/bit rate that is supported by the unit.

Protect

- A copy-protected WMA file was played back.
 - You can only play back non-copy-protected files.

Indication for iPod Mode

No USB Unit

- The iPod/iPhone is not connected.
 - Make sure the iPod/iPhone is correctly connected (refer to “Connections” on page 50).
Make sure the cable is not bent excessively.

No Song

- There are no songs in the iPod/iPhone.
 - Download songs to the iPod/iPhone and connect to this unit.

Error-01

- Communication error or boot error, etc.
 - You can solve the problem by reconnecting the iPod/iPhone or changing source.

Error-02

- The iPod/iPhone version is too low.
 - Update the iPod/iPhone version.

Error-03

- The iPod/iPhone is not verified.
 - You can solve the problem by reconnecting the iPod/iPhone.

Indication for vTuner Mode

No Station

- The application cannot stream the audio data or the station has been deleted, etc.
 - Change another station.

Server Error

- There is something wrong with vTuner’s server.
 - Wait until the connection recovery or change to other source by pressing  /SOURCE.

No Support

- The selected station’s audio file format cannot be supported by vTuner application.
 - Select another station.

(Blank)

- The vTuner application installed for the first time.
- The resuming playback station is deleted from iPhone.
 - Select another station.

See Device

- The music cannot be played because the vTuner Compatible Application for iPhone requires the user’s attention. Or no vTuner application is installed in iPhone.
 - When you are not driving, please see the vTuner Compatible Application for iPhone.

No Service

- The device cannot be connected to vTuner internet radio. Or the connected iPhone does not support vTuner.
 - Change another iPhone that supports vTuner.
 - Select a source other than vTuner by pressing  /SOURCE.

Buffering

- The iPhone is buffering broadcast programmes while receiving or after receiving the station.
 - Wait until the buffering finishes.

Loading

- The loading is in process to display the receivable station list.
- The station list is being transferred.
 - No necessary operation.

BLUETOOTH mode

No Unit

- The BLUETOOTH device is not connected.
 - Connect the BLUETOOTH device.

Specifications

FM TUNER SECTION

Tuning Range	87.5-108.0 MHz
Mono Usable Sensitivity	0.7 μ V
Alternate Channel Selectivity	80 dB
Signal-to-Noise Ratio	65 dB
Stereo Separation	35 dB
Capture Ratio	2.0 dB

MW TUNER SECTION

Tuning Range	531-1,602 kHz
Sensitivity (IEC Standard)	25.1 μ V/28 dB

LW TUNER SECTION

Tuning Range	153-281 kHz
Sensitivity (IEC Standard)	31.6 μ V/30 dB

CD PLAYER SECTION

Frequency Response	5-20,000 Hz (\pm 1 dB)
Wow & Flutter (% WRMS)	Below measurable limits
Total Harmonic Distortion	0.008% (at 1 kHz)
Dynamic Range	95 dB (at 1 kHz)
Signal-to-Noise Ratio	105 dB
Channel Separation	85 dB (at 1 kHz)

PICKUP

Wave length	795 nm
Laser power	CLASS I

USB SECTION

USB requirements	USB 1.1/2.0
Max. Power Consumption	Smartphone charge-capable
USB Class	Mass Storage
File System	FAT 12/16/32
MP3 Decoding	MPEG AUDIO Layer-3
WMA Decoding	Windows Media™ Audio
AAC Decoding	AAC-LC format “.m4a” file

BLUETOOTH SECTION

BLUETOOTH Specification	Bluetooth V2.1 + EDR
Output Power	+4 dBm Max. (Power class 2)
Profile	HFP (Hands-Free Profile) HSP (Head Set Profile) A2DP (Advanced Audio Distribution Profile) AVRCP (Audio/Video Remote Control Profile)

GENERAL

Power Requirement	14.4 V DC (11-16 V allowable)
Maximum Power Output	50 W \times 4
Maximum Pre-Output Voltage	2 V/10 k ohms (CDE-175R) 4 V/10 k ohms (CDE-178BT/iDE-178BT)
Bass	\pm 9.1db at 100Hz
Treble	\pm 9.1db at 10kHz
Loudness	10db at 100Hz
Weight	1.5 kg (3 lbs. 5 oz) (CDE-178BT/CDE-175R) 1.1 kg (2 lbs. 7 oz) (iDE-178BT)

CHASSIS SIZE

Width	178 mm (7")
Height	50 mm (2")
Depth	161.5 mm (6-3/8")

NOSEPIECE SIZE

Width	168 mm (6-3/4")
Height	45 mm (1-3/4")
Depth	24 mm (1")

Note

- Due to continuous product improvement, specifications and design are subject to change without notice.

CAUTION



(Bottom side of player)

Installation and Connections

Before installing or connecting the unit, please read the following and refer to "Operating Instructions" on page 6 for proper use.

WARNING

MAKE THE CORRECT CONNECTIONS.

Failure to make the proper connections may result in fire or product damage.

USE ONLY IN CARS WITH A 12 VOLT NEGATIVE GROUND.

(Check with your dealer if you are not sure.) Failure to do so may result in fire, etc.

BEFORE WIRING, DISCONNECT THE CABLE FROM THE NEGATIVE BATTERY TERMINAL.

Failure to do so may result in electric shock or injury due to electrical shorts.

DO NOT SPLICE INTO ELECTRICAL CABLES.

Never cut away cable insulation to supply power to other equipment. Doing so will exceed the current carrying capacity of the wire and result in fire or electric shock.

DO NOT DAMAGE PIPE OR WIRING WHEN DRILLING HOLES.

When drilling holes in the chassis for installation, take precautions so as not to contact, damage or obstruct pipes, fuel lines, tanks or electrical wiring. Failure to take such precautions may result in fire.

DO NOT USE BOLTS OR NUTS IN THE BRAKE OR STEERING SYSTEMS TO MAKE GROUND CONNECTIONS.

Bolts or nuts used for the brake or steering systems (or any other safety-related system), or tanks should NEVER be used for installations or ground connections. Using such parts could disable control of the vehicle and cause fire etc.

KEEP SMALL OBJECTS SUCH AS BATTERIES OUT OF THE REACH OF CHILDREN.

Swallowing them may result in serious injury. If swallowed, consult a physician immediately.

DO NOT INSTALL IN LOCATIONS WHICH MIGHT HINDER VEHICLE OPERATION, SUCH AS THE STEERING WHEEL OR SHIFT LEVER.

Doing so may obstruct forward vision or hamper movement etc. and results in serious accident.

DO NOT ALLOW CABLES TO BECOME ENTANGLED IN SURROUNDING OBJECTS.

Arrange wiring and cables in compliance with the manual to prevent obstructions when driving. Cables or wiring that obstruct or hang up on places such as the steering wheel, shift lever, brake pedals, etc. can be extremely hazardous.

CAUTION

HAVE THE WIRING AND INSTALLATION DONE BY EXPERTS.

The wiring and installation of this unit requires special technical skill and experience. To ensure safety, always contact the dealer where you purchased this product to have the work done.

USE SPECIFIED ACCESSORY PARTS AND INSTALL THEM SECURELY.

Be sure to use only the specified accessory parts. Use of other than designated parts may damage this unit internally or may not securely install the unit in place. This may cause parts to become loose resulting in hazards or product failure.

ARRANGE THE WIRING SO IT IS NOT CRIMPED OR PINCHED BY A SHARP METAL EDGE.

Route the cables and wiring away from moving parts (like the seat rails) or sharp or pointed edges. This will prevent crimping and damage to the wiring. If wiring passes through a hole in metal, use a rubber grommet to prevent the wire's insulation from being cut by the metal edge of the hole.

DO NOT INSTALL IN LOCATIONS WITH HIGH MOISTURE OR DUST.

Avoid installing the unit in locations with high incidence of moisture or dust. Moisture or dust that penetrates into this unit may result in product failure.

PRECAUTIONS

- Be sure to disconnect the cable from the (-) battery post before installing your CDE-178BT/iDE-178BT/CDE-175R. This will reduce any chance of damage to the unit in case of a short-circuit.
- Be sure to connect the colour coded leads according to the diagram. Incorrect connections may cause the unit to malfunction or damage to the vehicle's electrical system.
- When making connections to the vehicle's electrical system, be aware of the factory installed components (e.g. on-board computer). Do not tap into these leads to provide power for this unit. When connecting the CDE-178BT/iDE-178BT/CDE-175R to the fuse box, make sure the fuse for the intended circuit of the CDE-178BT/iDE-178BT/CDE-175R has the appropriate amperage. Failure to do so may result in damage to the unit and/or the vehicle. When in doubt, consult your Alpine dealer.
- The CDE-178BT/iDE-178BT/CDE-175R uses female RCA-type jacks for connection to other units (e.g. amplifier) having RCA connectors. You may need an adaptor to connect other units. If so, please contact your authorized Alpine dealer for assistance.
- Be sure to connect the speaker (-) leads to the speaker (-) terminal. Never connect left and right channel speaker cables to each other or to the vehicle body.

IMPORTANT

Please record the serial number of your unit in the space provided below and keep it as a permanent record. The serial number or the engraved serial number is located on the bottom of the unit.

SERIAL NUMBER: []
INSTALLATION DATE: []
INSTALLATION TECHNICIAN: []
PLACE OF PURCHASE: []

Installation

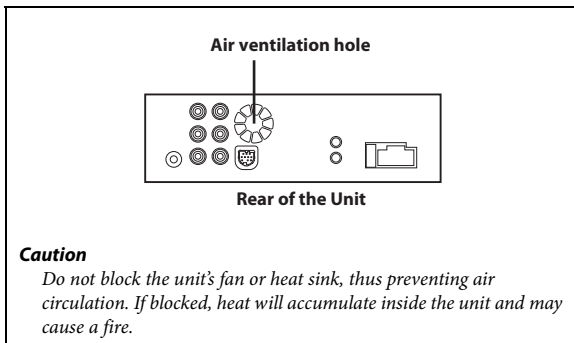

CAUTION

When you install this unit in your car, do not remove the detachable front panel. If the detachable front panel is removed during installation, you might press too hard and warp the metal plate that holds it in place. The main unit must be mounted within 35 degrees of the horizontal plane, back to front.

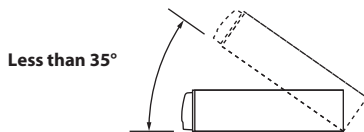
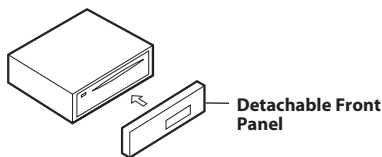

- 1 Remove the mounting sleeve from the main unit (refer to "Removal" on page 48). Slide the mounting sleeve into the dashboard and fix it with the metal shackles.

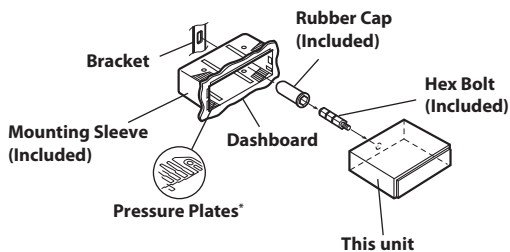

* If the installed mounting sleeve is loose in the dashboard, the pressure plates may be bent slightly to remedy the problem.

- 2 When your vehicle has the Bracket, mount the long hex bolt onto the rear panel of the CDE-178BT/iDE-178BT/CDE-175R and put the Rubber Cap on the hex bolt. If your vehicle does not have the Mounting Support, reinforce the head unit with the metal mounting strap (not supplied). Connect all other leads of the CDE-178BT/iDE-178BT/CDE-175R according to details described in the CONNECTIONS section.

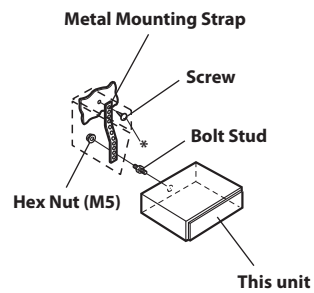

Note

- For the screw*, provide a proper screw to the chassis installing location.

- 3 Slide the CDE-178BT/iDE-178BT/CDE-175R into the dashboard. When the unit is in place, make sure the locking pins are fully seated in the down position. This can be done by pressing firmly in on the unit while pushing the locking pin down with a small screwdriver. This ensures that the unit is properly locked and will not accidentally come out from the dashboard. Install the detachable front panel.

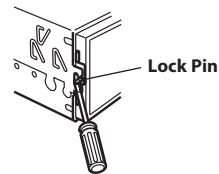

Removal

- 1 Remove the detachable front panel.
- 2 Use a small screwdriver (or similar tool) to push the locking pins to the "up" position (see above drawing). As each pin is unlocked, gently pull out on the unit to make sure it does not re-lock before unlocking the second pin.
- 3 Pull the unit out, keeping it unlocked as you do so.

JAPANESE CAR

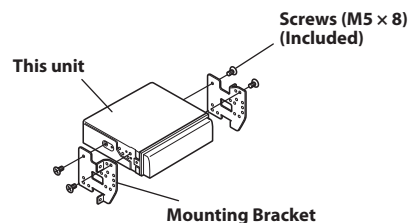
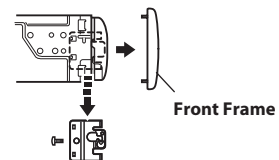

iPod/iPhone Connection (sold separately)

Connect USB cable to an iPod/iPhone with Interface cable for iPod.

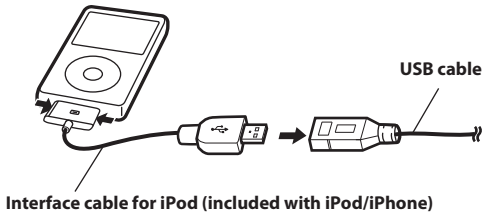

Remove the iPod/iPhone

Remove the iPod/iPhone from Interface cable for iPod.

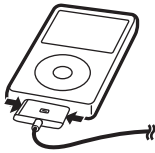

Notes

- After changing the unit to a source other than the iPod, remove the iPod/iPhone. If the iPod/iPhone is removed in the iPod mode, data may cause damage.
- If sound is not output or the iPod/iPhone is not recognised even when the iPod/iPhone is connected, remove the iPod/iPhone once, then connect it again, or reset the iPod.
- Do not leave the iPod/iPhone in a vehicle for a long time. Heat and humidity may damage the iPod/iPhone and you may not be able to play it again.

USB Memory Connection (sold separately)

Connect USB Memory

Connect the USB cable to the USB connector of the unit.

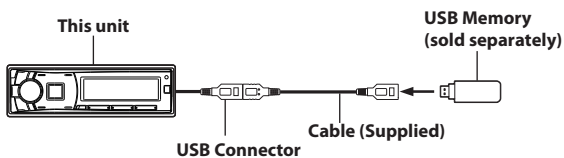

Remove USB Memory

Pull out USB Memory squarely from the USB cable.

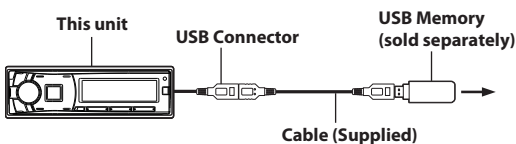

Notes

- When removing USB Memory, pull it out straight.
- If sound is not output or USB Memory is not recognized even when USB Memory is connected, remove USB Memory once, then connect it again.

- Change to a source other than the USB mode, then remove the USB Memory. If the USB Memory is removed in the USB mode, data may be damaged.
- Route the USB cable away from another cables.

Mounting the Microphone (Only for CDE-178BT/iDE-178BT)

For the sake of safety, mount the microphone in the following location.

- In a stable and secure location.
- In a location that does not inhibit safely driving the vehicle.
- Mount the microphone in a location where the driver's voice can easily be picked up.

Choose a location for the microphone that can easily pick up the drivers voice. Requiring the driver to move towards the microphone for audibility causes a distraction that could be dangerous.

Using the Rear AUX Input Connector

Connect a portable music player, etc. by simply connecting it to the Rear Aux Input Connector. An optional adapter cable is required (standard RCA to 3.5ø mini-phono plug or 3.5ø to 3.5ø mini phono plug).

Press /SOURCE, and select the Auxiliary mode to listen to the portable device.

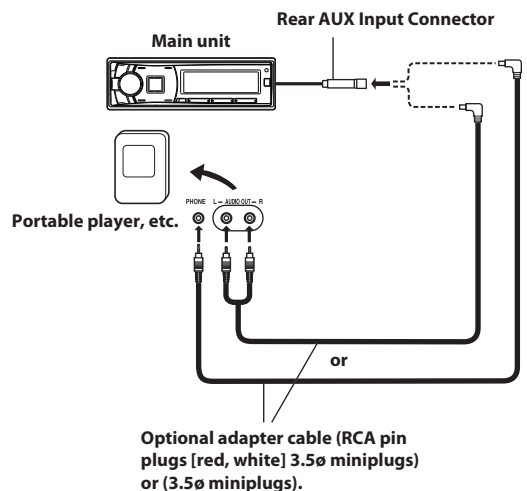

Note

- This function is available only when AUX IN is set to ON. For details, refer to "Setting the AUX SETUP mode" on page 28.

Connections

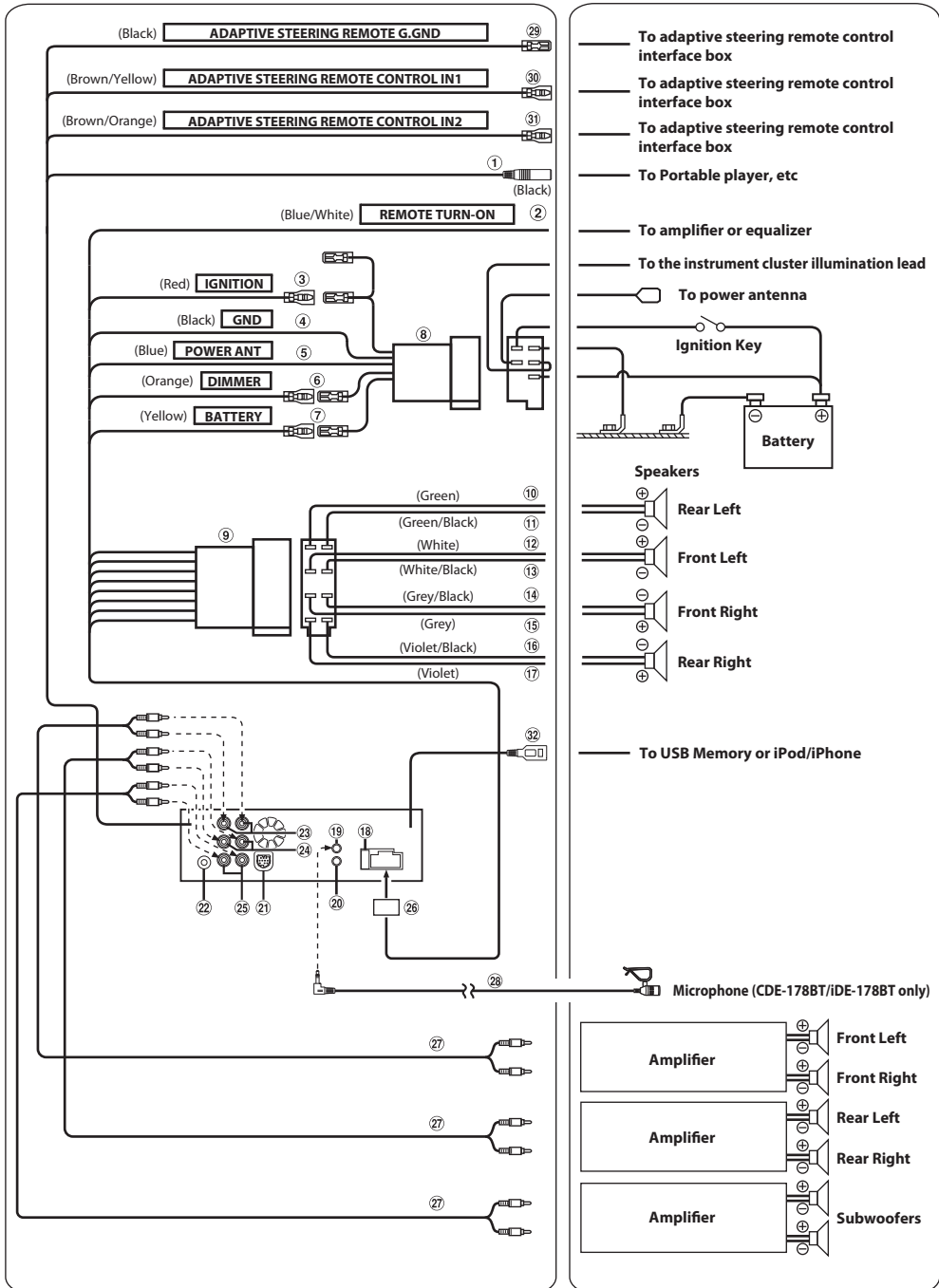

- ① **Rear Aux Input Connector (Black)**
This connector allows for input of audio from an external device (such as a portable player), using a commercially-available converter cable.
- ② **Remote Turn-On Lead (Blue/White)**
Connect this lead to the remote turn-on lead of your amplifier or signal processor.
- ③ **Switched Power Lead (Ignition) (Red)**
Connect this lead to an open terminal on the vehicle's fuse box or another unused power source which provides (+) 12V only when the ignition is turned on or in the accessory position.
- ④ **Ground Lead (Black)**
Connect this lead to a good chassis ground on the vehicle. Make sure the connection is made to bare metal and is securely fastened using the sheet metal screw provided.
- ⑤ **Power Antenna Lead (Blue)**
Connect this lead to the +B terminal of your power antenna, if applicable.
Note
 - This lead should be used only for controlling the vehicle's power antenna. Do not use this lead to turn on an amplifier or a signal processor, etc.
- ⑥ **Dimmer Lead (Orange)**
This lead may be connected to the vehicle's instrument cluster illumination lead. This will enable the vehicle's dimmer control to dim the backlighting of the unit.
- ⑦ **Battery Lead (Yellow)**
Connect this lead to the positive (+) post of the vehicle's battery.
- ⑧ **ISO Power Supply Connector**
- ⑨ **ISO Connector (Speaker Output)**
- ⑩ **Left Rear (+) Speaker Output Lead (Green)**
- ⑪ **Left Rear (-) Speaker Output Lead (Green/Black)**
- ⑫ **Left Front (+) Speaker Output Lead (White)**
- ⑬ **Left Front (-) Speaker Output Lead (White/Black)**
- ⑭ **Right Front (-) Speaker Output Lead (Grey/Black)**
- ⑮ **Right Front (+) Speaker Output Lead (Grey)**
- ⑯ **Right Rear (-) Speaker Output Lead (Violet/Black)**
- ⑰ **Right Rear (+) Speaker Output Lead (Violet)**
- ⑱ **Fuse Holder (10A)**
- ⑲ **MIC Input Connector (CDE-178BT/iDE-178BT only)**
To Microphone.
- ⑳ **Steering Remote Control Interface Connector**
To steering remote control interface box.
For details, contact your Alpine dealer.
- ㉑ **OEM Sub-display interface Connector**
Connect this to the optional OEM Sub-display interface box.
For details about connections, consult your nearest Alpine dealer.
- ㉒ **Antenna Receptacle**
- ㉓ **Front Output Input RCA Connectors**
It can be used as Front Output or Input RCA connectors.
RED is right and WHITE is left.
- ㉔ **Rear Output Input RCA Connectors**
It can be used as Rear Output or Input RCA connectors.
RED is right and WHITE is left.
- ㉕ **Subwoofer Output RCA Connectors**
RED is right and WHITE is left.
- ㉖ **Power Supply Connector**
- ㉗ **RCA Extension Cable (sold separately)**
- ㉘ **Microphone (Included) (CDE-178BT/iDE-178BT only)**
- ㉙ **Adaptive Steering Remote G.GND**
To adaptive steering remote control interface box.
For details about connections, consult your nearest Alpine dealer.

- ⑳ **Adaptive Steering Remote Control In 1 Lead (Brown/Yellow)**
To adaptive steering remote control interface box.
For details about connections, consult your nearest Alpine dealer.
- ㉑ **Adaptive Steering Remote Control In 2 Lead (Brown/Orange)**
To adaptive steering remote control interface box.
For details about connections, consult your nearest Alpine dealer.
- ㉒ **USB Connector**
Connect this to an USB Memory or to an iPod/iPhone. To use an iPod/iPhone, Interface cable for iPod connection is required.

Notes

- Use the supplied USB cable. If a USB cable other than the supplied is used, correct performance cannot be guaranteed.
- Route the USB cable away from other cables.

To prevent external noise from entering the audio system.

- Locate the unit and route the leads at least 10 cm away from the car harness.
- Keep the battery power leads as far away from other leads as possible.
- Connect the ground lead securely to a bare metal spot (remove any paint, dirt or grease if necessary) of the car chassis.
- If you add an optional noise suppressor, connect it as far away from the unit as possible. Your Alpine dealer carries various noise suppressors, contact them for further information.
- Your Alpine dealer knows best about noise prevention measures so consult your dealer for further information.

About the Rules of Bluetooth Electromagnetic Radiation Regulation



Declaration of Conformity

Declaration of Conformity

We, the undersigned,

Authorized representative in Europe : Alpine Electronics (Europe) GmbH

Address, City : Wilhelm-Wagenfeld-Strasse 1-3, D-80807, Munich

Country : Germany

certify and declare under our sole responsibility that the following apparatus :

Description : CD Receiver

Manufacturer : Alpine Electronics, Inc.

Brand : ALPINE

Identification : CDE-178BT

Installed Bluetooth module : UGZZC-G

Test Report No. :

Radio : T36209-00-01TK (DAkKS)

EMC : T36209-00-02KT (DAkKS)

LVD : S123636E2 (PHOENIX TESTLAB GmbH, Blomberg)

conforms with the essential requirements of the Radio and Telecommunications Terminal Equipment Directive 1999/5/EC, based on the following specifications applied:

Radio : EN300328 V1.7.1

EMC : EN301489-1 V1.9.2 EN301 489-17 V2.1.1

LVD : EN 60950-1: 2006 + A1: 2010 + A11: 2009 + A1:2010+A12:2011

and therefore complies with the essential requirements and provisions of the R&TTE Directive.

The Technical documentation is kept at the following address:

Company : Alpine Electronics (Europe) GmbH

Address, City : Wilhelm-Wagenfeld-Strasse 1-3, D-80807, Munich

Country : Germany

Phone number : 49(0)89-324264-240

Fax number/e-mail : 49(0)89-324264-241

Name and position of person binding the manufacturer or his authorized representative : **Yoshihisa Endo
Global Engineering Strategy Office
Alpine Electronics, Inc.**

Signature of the authorized person : *Yoshihisa Endo*

Date of issue : **October 25, 2012**

Declaration of Conformity

We, the undersigned,

Authorized representative in Europe : Alpine Electronics (Europe) GmbH

Address, City : Wilhelm-Wagenfeld-Strasse 1-3, D-80807, Munich

Country : Germany

certify and declare under our sole responsibility that the following apparatus :

Description : CD Receiver

Manufacturer : Alpine Electronics, Inc.

Brand : ALPINE

Identification : iDE-178BT

Installed Bluetooth module : UGZZC-G

Test Report No. :

Radio : T36209-00-01TK (DAkKS)

EMC : T36209-00-02KT (DAkKS)

LVD : S123636E2 (PHOENIX TESTLAB GmbH, Blomberg)

conforms with the essential requirements of the Radio and Telecommunications Terminal Equipment Directive 1999/5/EC, based on the following specifications applied:

Radio : EN300328 V1.7.1

EMC : EN301489-1 V1.9.2 EN301 489-17 V2.1.1

LVD : EN 60950-1: 2006 + A1: 2010 + A11: 2009 + A1:2010+A12:2011

and therefore complies with the essential requirements and provisions of the R&TTE Directive.

The Technical documentation is kept at the following address:

Company : Alpine Electronics (Europe) GmbH

Address, City : Wilhelm-Wagenfeld-Strasse 1-3, D-80807, Munich

Country : Germany

Phone number : 49(0)89-324264-240

Fax number/e-mail : 49(0)89-324264-241

Name and position of person binding the manufacturer or his authorized representative : **Yoshihisa Endo
Global Engineering Strategy Office
Alpine Electronics, Inc.**

Signature of the authorized person : *Yoshihisa Endo*

Date of issue : **October 25, 2012**